

SpectraMax i3x

Multi-Mode Microplate Reader

With the SpectraMax MiniMax 300 Imaging Cytometer

User Guide

SpectraMax i3x Multi-Mode Microplate Reader User Guide

This document is provided to customers who have purchased Molecular Devices equipment, software, reagents, and consumables to use in the operation of such Molecular Devices equipment, software, reagents, and consumables. This document is copyright protected and any reproduction of this document, in whole or any part, is strictly prohibited, except as Molecular Devices may authorize in writing.

Software that may be described in this document is furnished under a non-transferrable license. It is against the law to copy, modify, or distribute the software on any medium, except as specifically allowed in the license agreement. Furthermore, the license agreement may prohibit the software from being disassembled, reverse engineered, or decompiled for any purpose.

Portions of this document may make reference to other manufacturers and/or their products, which may contain parts whose names are registered as trademarks and/or function as trademarks of their respective owners. Any such usage is intended only to designate those manufacturers' products as supplied by Molecular Devices for incorporation into its equipment and does not imply any right and/or license to use or permit others to use such manufacturers' and/or their product names as trademarks.

Each product is shipped with documentation stating specifications and other technical information. Molecular Devices products are warranted to meet the stated specifications. Molecular Devices makes no other warranties or representations express or implied, including but not limited to, the fitness of this product for any particular purpose and assumes no responsibility or contingent liability, including indirect or consequential damages, for any use to which the purchaser may put the equipment described herein, or for any adverse circumstances arising therefrom. The sole obligation of Molecular Devices and the customer's sole remedy are limited to repair or replacement of the product in the event that the product fails to do as warranted.

For research use only. Not for use in diagnostic procedures.

The trademarks mentioned herein are the property of Molecular Devices, LLC or their respective owners. These trademarks may not be used in any type of promotion or advertising without the prior written permission of Molecular Devices, LLC.

Patents: <http://www.moleculardevices.com/patents>

Product manufactured by Molecular Devices, LLC.
3860 N. First Street, San Jose, California, 95134, United States of America.
Molecular Devices, LLC is ISO 9001 registered.
©2023 Molecular Devices, LLC.
All rights reserved.



Contents

Safety Information	5
Warnings, Cautions, Notes, and Tips	5
Chapter 1: Introduction	11
Computer Integration	12
Applications	12
Optics	13
Plate Controls	14
Environmental Controls	15
Chapter 2: Setting Up the SpectraMax i3x Multi-Mode Microplate Reader	17
Package Contents	17
Unpacking the Instrument	18
Removing Transport Locks	20
Connecting Instrument Cables	23
Chapter 3: SpectraMax MiniMax 300 Imaging Cytometer	27
Whole-Cell Imaging	27
Setting Up the Cytometer	27
Chapter 4: Getting Started	41
Front Panel Controls and Indicators	42
Loading and Unloading Plates	45
Temperature Settings	48
Detection Cartridges	49
Chapter 5: Detection Cartridges	53
AlphaScreen Detection Cartridges	54
Fluorescence Intensity Detection Cartridges	56
Fluorescence Polarization Detection Cartridges	59
FRET Detection Cartridges	61
Imaging - Transmitted Light Detection Cartridge	62
Luminescence Detection Cartridges	64
ScanLater Western Blot Detection Cartridge	68
Time Resolved Fluorescence Detection Cartridges	71
Chapter 6: SpectraMax Injector Cartridge	75
Installing the Injector Cartridge	75
Using the SpectraMax Injector Cartridge	82

Removing the Injector Cartridge	97
Chapter 7: Read Modes and Read Types	113
Read Types	114
Absorbance Read Mode	116
AlphaScreen Read Mode	120
Fluorescence Intensity Read Mode	122
Fluorescence Polarization Read Mode	126
FRET Read Mode	129
HTRF Read Mode	130
Imaging Read Mode	133
Luminescence Read Mode	135
Time-Resolved Fluorescence Read Mode	138
Western Blot Read Mode	142
Chapter 8: Maintenance and Troubleshooting	145
Preventive Maintenance	145
Before You Move the Instrument	150
Preparing the Cytometer for Shipment	151
Preparing the Microplate Reader for Shipment	157
Troubleshooting	163
Obtaining Support	164
Appendix A: Instrument Specifications	165
Measurement Specifications	165
Cytometer Measurement Specifications	168
Physical Specifications	169
Appendix B: System Diagrams and Dimensions	171
Electromagnetic Compatibility	174

Safety Information

Information about the safe use of the instrument from Molecular Devices includes an understanding of the user-attention statements in this guide, the safety labels on the instrument, precautions to follow before you operate the instrument, and precautions to follow while you operate the instrument.

Make sure that everyone involved with the operation of the instrument has:

- Received instruction in general safety practices for laboratories.
- Received instruction in specific safety practices for the instrument.
- Read and understood all Safety Data Sheets (SDS) for all materials being used.

Read and observe all warnings, cautions, and instructions. The most important key to safety is to operate the instrument with care.



WARNING! If the instrument is used in a manner not specified by Molecular Devices, the protection provided by the equipment might be impaired.

Warnings, Cautions, Notes, and Tips

All warning symbols are framed within a yellow triangle. An exclamation mark is used for most warnings. Other symbols can warn of other types of hazards such as biohazard, electrical, or laser safety warnings as are described in the text of the warning. Follow the related safety information.

The following user attention statements might be displayed in the text of Molecular Devices user documentation. Each statement implies the amount of observation or recommended procedure.



WARNING! A warning indicates a situation or operation that could cause personal injury if precautions are not followed.



CAUTION! A caution indicates a situation or operation that could cause damage to the instrument or loss of data if correct procedures are not followed.











Note: A note calls attention to significant information.



Tip: A tip provides useful information or a shortcut but is not essential to the completion of a procedure.

Symbols on the Instrument

Each safety label found on the instrument contains an alert symbol that indicates the type of potential safety hazard.

Symbol	Indication
	Consult the product documentation.
	Potential laser hazard. The instrument is rated a Class 1 Laser Product because it can house one or more laser modules, and the laser light cannot be accessed.
	Potential lifting hazard. To prevent injury, use a minimum of two people to lift the instrument.
	Electrostatic sensitive device (ESD). Observe precautions for handling electrostatic sensitive devices.
	Power switch indicates power on.
	Power switch indicates power off.
	Required in accordance with the Waste Electrical and Electronic Equipment (WEEE) Directive of the European Union. It indicates that you must not discard this electrical or electronic product or its components in domestic household waste or in the municipal waste collection system. For products under the requirement of the WEEE directive, contact your dealer or local Molecular Devices office for the procedures to facilitate the proper collection, treatment, recovery, recycling, and safe disposal of the device.
	United Kingdom and/or Korean technology conformity.
	California proposition 65 requires businesses to provide warnings to Californians about significant exposures to chemicals that cause cancer, birth defects, or other reproductive harm.

Electrical Safety

To prevent electrical injuries and property damage, inspect all electrical equipment before use and report all electrical deficiencies. Contact Molecular Devices technical support for equipment service that requires the removal of covers or panels.



WARNING! HIGH VOLTAGE. Within the instrument is the potential of an electrical shock hazard existing from a high voltage source. Read and understand all safety instructions before you install, maintain, and service the instrument.

To prevent electrical shock, use the supplied power cord and connect to a properly grounded wall outlet.

To ensure sufficient ventilation and provide access to disconnect power from the instrument, maintain a 20 cm to 30 cm (7.9 in. to 11.8 in.) gap between the rear of the instrument and the wall.

Power off the instrument when not in use.

Laser Safety



WARNING! LASER LIGHT. This symbol indicates that a potential hazard to personal safety exists from a laser source. When this symbol displays in this guide, follow the specific safety information related to the symbol.

The SpectraMax® i3x Multi-Mode Microplate Reader is rated a Class 1 Laser Product because it can house one or more laser modules, and the laser light cannot be accessed.

The SpectraMax i3x is equipped with a redundant laser safety system. A hardware interlock prevents the laser module from turning on, unless the plate chamber door is closed and the front cover of the detection cartridge drawer is in place. The user or the service engineer is not exposed to radiation from the laser module during operation, maintenance, or service. The closed plate chamber provides the protective housing.



WARNING! LASER LIGHT. Operate the instrument only when all the doors and panels of the instrument are in place and closed.

Laser or Laser Diodes in Detection Cartridges

Some detection cartridges can have a laser or laser diode up to Laser Class 4 inside the detection cartridge. The lasers are non-operational until after the detection cartridges are properly installed in the SpectraMax i3x.

Laser in the SpectraMax MiniMax 300 Imaging Cytometer

The SpectraMax® MiniMax™ 300 Imaging Cytometer has a Laser Class 2 laser inside the instrument but it is rated a Class 1 Laser Product because the laser light cannot be accessed.

The laser is non-operational until after the cytometer is properly installed on the SpectraMax i3x.

The optics access cover on the bottom of the SpectraMax i3x has a hardware interlock that prevents the laser module from turning on, unless the cover is in place. The installed cover closes the protective housing.

Chemical and Biological Safety

Normal operation of the instrument can involve the use of materials that are toxic, flammable, or otherwise biologically harmful. When you use such materials, observe the following precautions:

- Handle infectious samples based on good laboratory procedures and methods to prevent the spread of disease.
- Observe all cautionary information printed on the original containers of solutions before their use.
- Dispose of all waste solutions based on the waste disposal procedures of your facility.
- Operate the instrument in accordance with the instructions outlined in this guide, and take all the required precautions when using pathological, toxic, or radioactive materials.
- Splashing of liquids can occur. Take applicable safety precautions, such as using safety glasses and wearing protective clothing, when working with potentially hazardous liquids.
- Observe the applicable cautionary procedures as defined by your safety officer when using hazardous materials, flammable solvents, toxic, pathological, or radioactive materials in or near a powered-up instrument.
- Use a compressed gas supply in a well-ventilated area. The instrument is not air-tight. Gas can escape into the atmosphere surrounding the instrument. When you use potentially toxic gas, observe the cautionary procedures your safety officer defines to maintain a safe work environment.



WARNING! Never use the instrument in an environment where potentially damaging liquids or gases are present.



CAUTION! Use of organic solvents can cause harm to the optics in the instrument. Extreme caution is recommended when you use organic solvents. Always use a plate lid and do not place a plate that contains these materials in the plate chamber for prolonged periods of time. Damage caused by the use of incompatible or aggressive solvents is NOT covered by the instrument warranty.

Moving Parts Safety

The instrument contains moving parts that can cause injury. Under normal conditions, the instrument is designed to protect you from these moving parts.



WARNING! If the instrument is used in a manner not specified by Molecular Devices, the protection provided by the equipment might be impaired.

To prevent injury:

- Never try to exchange labware, reagents, or tools while the instrument is operating.
- Never try to physically restrict the moving components of the instrument.
- Keep the instrument work area clear to prevent obstruction of the movement. Provide clearance in the front of the instrument of 18 cm (7.1 in.) for the plate drawer and 15 cm (5.9 in.) for the detection cartridge drawer.
- The instrument has adjustable optics to define the read height, or z-height. In a top read, the read height is the gap between the lens and the top of the plate, or the top of the lid if the plate is lidded.



CAUTION! To prevent damage to the instrument, set the plate height and read height accurately before you start a read. If the plate has a lid, you must select the Is Lidded check box in the Settings dialog and verify that the plate height with a lid is set accurately in the Plate Editor dialog before you start a read.

There are transport locks on the detection cartridge drawer and the plate drawer to protect the instrument from damage during shipping. You must remove the transport locks before you power on the instrument.



**REMOVE BOTH TRANSPORT LOCKS
(CARTRIDGE DRAWER AND PLATE DRAWER)
BEFORE SWITCHING THE DEVICE ON**



To move the plate drawer or the detection cartridge drawer into or out of the instrument, always use the buttons on the keypad or the controls in the software. See [Loading and Unloading Plates on page 45](#) or [Detection Cartridges on page 49](#).

To move the plate drawer or the detection cartridge drawer into or out of the instrument, always use the buttons on the keypad or the controls in the software. See [Loading and Unloading Plates on page 45](#) or [Detection Cartridges on page 49](#).



CAUTION! To prevent damage to the installed detection cartridges and the instrument, do not manually slide the detection cartridge drawer in or out when the instrument is powered on or when one or more detection cartridges are installed in the drawer.



WARNING! Do not attempt to access the interior of the instrument unless specifically instructed to do so. The moving parts inside the instrument can cause injury. Do not operate the instrument with any covers or panels removed.



The SpectraMax i3x Multi-Mode Microplate Reader is a monochromator-based, multi-mode detection platform. You can mount the SpectraMax i3x on the SpectraMax MiniMax 300 Imaging Cytometer to add imaging capability to visually inspect your sample and to run cell-based assays at cellular or whole-cell resolution. See [SpectraMax MiniMax 300 Imaging Cytometer on page 27](#).

The SpectraMax i3x built-in read modes include:

- [Absorbance Read Mode on page 116](#) (UV and Visible)
- [Fluorescence Intensity Read Mode on page 122](#)
- [Luminescence Read Mode on page 135](#)

The SpectraMax i3x supports user-installable detection cartridges to expand its read capabilities. Each detection cartridge contains the light source, optics, and electrical components needed to do specific read modes. You can install up to three detection cartridges in the detection cartridge drawer. See [Detection Cartridges on page 53](#).

Most read modes support the following read types:

- [Endpoint Read Type on page 114](#)
- [Kinetic Read Type on page 114](#)
- [Membrane Read Type on page 114](#)
- [Spectrum Read Type on page 114](#)
- [Well Scan Read Type on page 115](#)

Depending on the application, the instrument can read 6, 12, 24, 48, 96, and 384-well plates. For micro-volume measurements, the instrument supports SpectraDrop 24-well Low Volume Microplate and SpectraDrop 64-well Low Volume Microplate. The instrument can read 1536-well microplates when you install specific detection cartridges.



CAUTION! To prevent damage to the instrument, the height of the plate must not exceed 17 mm, including the lid if the plate is lidded.

You can integrate the SpectraMax i3x with the StakMax® Microplate Handling System.

Computer Integration

Each Molecular Devices microplate reader ships with a license key for the SoftMax® Pro Data Acquisition and Analysis Software. You install the SoftMax Pro Software on the computer that you use to operate the instrument to provide integrated instrument control, data display, and statistical data analysis.

You should install the SoftMax Pro Software on the computer before you set up the instrument. Please be aware that some updates to the SoftMax Pro Software require a purchase. Contact Molecular Devices before you update the software.

For information about the computer specifications required to run the software, the software installation and licensing instructions, and the directions to create the software connection between the computer and the instrument, see:

- *SoftMax Pro Data Acquisition and Analysis Software - Standard Edition and MiniMax Imaging Edition - Installation Guide*
- *SoftMax Pro Data Acquisition and Analysis Software - GxP Edition - Installation Guide for the Multi Computer Setup*
- *SoftMax Pro Data Acquisition and Analysis Software - GxP Edition - Installation Guide for the Single Computer Setup*

The SpectraMax MiniMax 300 Imaging Cytometer ships with a computer that meets greater minimum computer system specifications than those required for the standard SoftMax Pro Software installation. You must install the SoftMax Pro Software - MiniMax Imaging Edition of the SoftMax Pro Software on the supplied computer to operate the SpectraMax i3x with the SpectraMax MiniMax 300 Imaging Cytometer. Use of the SpectraMax MiniMax 300 Imaging Cytometer does not support the SoftMax Pro Software - GxP edition.

Applications

The high sensitivity and flexibility of the SpectraMax i3x make it useful for applications in the fields of biochemistry, cell biology, immunology, molecular biology, and microbiology.

Typical applications include ELISA, nucleic acid, protein, enzymatic type homogeneous and heterogeneous assays, microbial growth, endotoxin testing, and pipettor calibration.

Application notes with specific application protocol suggestions are in the Information Center and Knowledge Base on the Molecular Devices web site at www.moleculardevices.com.

Optics

The 2x2 monochromators permit individual optimization of wavelengths for both excitation and emission in fluorescence readings. Mirrored optics shape the light, and a height-adjustable objective lens focuses the beam into the sample volume. Outside of the LED range, you can set the PMT Gain to automatic, high, medium, low, or manual.



CAUTION! To prevent damage to the instrument, set the plate height and read height accurately before you start a read. If the plate has a lid, you must select the Is Lidded check box in the Settings dialog and verify that the plate height with a lid is set accurately in the Plate Editor dialog before you start a read. See the *SoftMax Pro Data Acquisition and Analysis Software User Guide* or the application help.

Dynamic Range

The dynamic range of detection is approximately from 10^{-6} to 10^{-12} molar fluorescein. Variations in measured fluorescence values are virtually eliminated by internal compensation for detector sensitivity, photomultiplier tube voltage and sensitivity, and excitation intensity. The photometric range is 0.000 to 4.000 ODs with a resolution of 0.001 OD.



CAUTION! Never touch the optic mirrors, lenses, filters, or cables. The optics are extremely delicate, and critical to the function of the instrument.



CAUTION! Use of organic solvents (such as dichloromethane) can cause harm to the optics in the instrument. Extreme caution is recommended when you use organic solvents. Always use a plate lid and do not place a plate that contains these materials in the plate chamber for prolonged periods of time. Damage caused by the use of incompatible or aggressive solvents is NOT covered by the instrument warranty.

Plate Controls

Plate controls include Shake and On-the-Fly Detection. The instrument can also detect the height of a plate in the plate drawer.

Shake

The Shake feature allows you to mix the contents of the wells in a plate inside the plate chamber before each read cycle, making it possible to do kinetic analysis of solid-phase, enzyme-mediated reactions.

The following shake settings are available:

- **Intensity:** Low, Medium, or High. The actual shake speed is based on the plate format.
- **Direction:** Linear or Orbital patterns.
- **Duration:** Length of time in seconds (1 to 999).

You should use the shake feature for ELISAs and other solid-phase, enzyme-mediated reactions to enhance accuracy.

On-the-Fly Detection

Some detection cartridges support On-the-Fly Detection that allow the instrument to read plates as the plate drawer moves within the chamber instead of pausing the plate drawer to read each well. This results in shorter read times.

There are two On-the-Fly Detection modes:

- **Performance:** A faster read time than not using On-the Fly Detection. This setting is not as fast as Speed in order to provide considerably better results than Speed for demanding assays.
- **Speed:** The fastest possible read time per plate. There is a trade-off between the data quality and read speed because Speed samples each well for shorter integration times.

The following table compares the read time for different plate types in each of the On-the-Fly detection modes. These read times do not include the time needed for the plate drawer to move the plate into the instrument and start the read, and then move the plate out of the instrument, which can add approximately 25 seconds to the overall read time.

Plate Read Times For On-The-Fly Detection (\pm 5 seconds)

Mode	96-Well	384-Well	1536-Well
Optimized for speed	20 seconds	33 seconds	68 seconds
Optimized for performance	28 seconds	45 seconds	96 seconds
Stop-and-go (off)	41 seconds	2 minutes	<5 minutes

Plate Height Sensing

You can use plates up to a height of 25 mm. A sensor detects the height of a plate and confirms that the height is consistent with the plate type you select in the software and that you positioned the plate properly on the plate drawer.



CAUTION! To prevent damage to the instrument, the height of the plate must not exceed 17 mm, including the lid if the plate is lidded.

Environmental Controls

The instrument environmental controls include temperature regulation and a gas inlet.

Temperature Regulation

The instrument can maintain the temperature inside the plate chamber at 4°C (7.2°F) above ambient to 45°C (113°F). Use the instrument touchscreen or the software to set and control the temperature. See [Temperature Settings on page 48](#) or the *SoftMax Pro Data Acquisition and Analysis Software User Guide* or the application help.



Note: The instrument temperature sensors detect the temperature of the air inside the chamber, not the temperature of the samples in the plate. If you use the instrument to warm the samples, you should use a seal or lid on the plate to prevent evaporation of the sample. A seal or lid helps to maintain uniform temperature. Letting the prepared sample equilibrate inside the plate chamber can take an hour or more. You can speed up equilibration by pre-warming the sample and the assay reagents before you place the plate in the chamber. Validate the data quality to determine whether the seal or lid can stay on the plate for the read.

Gas Inlet

The gas inlet allows you to apply partial pressure of CO₂, nitrogen, or other gas inside the plate chamber. This is useful for a cell-based assay in which you need to control the CO₂ environment to keep cell cultures alive. Neither the instrument nor the software controls or monitors the gas supply.



Note: The combination of temperature and CO₂ environment does not create a true CO₂ incubator environment in the instrument.

Use a compressed gas supply in a well-ventilated area. The instrument is not air-tight. Gas can escape into the atmosphere surrounding the instrument. When you use potentially toxic gas, observe the cautionary procedures your safety officer defines to maintain a safe work environment.



Chapter 2: Setting Up the SpectraMax i3x Multi-Mode Microplate Reader



Before you unpack and set up the SpectraMax i3x Multi-Mode Microplate Reader, prepare a dry, flat work area that has sufficient space for the instrument, host computer, and required cables. See [Instrument Specifications on page 165](#).





Note: If you use the SpectraMax MiniMax 300 Imaging Cytometer, follow the instructions to unpack the microplate reader but do not remove the transport locks. See [Setting Up the Cytometer on page 27](#).

Install the SoftMax Pro Software

Install the SoftMax Pro Software on the computer that operates the microplate reader.

There are specific computer settings for the SpectraMax MiniMax 300 Imaging Cytometer. If you use the cytometer, see [Setting Up the Cytometer on page 27](#).

Package Contents

Illustration	Part Number	Description
SoftMax Pro Software	Latest version	SoftMax Pro Software installation guide with Product Key
	YW 000 006	Hex key, 2.0 mm
	VZ 000 014	USB computer connection cable, 3 meter (9.8 foot)
	4400-0002 or 4400-0036	Power cord, 115V or Power cord, 230V

For a complete list of the contents of the package, see the enclosed packing list.



Note: Detection cartridges ship separately.

Unpacking the Instrument

The packaging is designed to protect the instrument during transportation.

There are transport locks on the detection cartridge drawer and the plate drawer to protect the instrument from damage during shipping. You must remove the transport locks before you power on the instrument.



WARNING! LIFTING HAZARD. To prevent injury, use a minimum of two people to lift the instrument.



Note: Retain the shipping box and all packaging materials for future transport needs. Do not use tools that can damage the packaging or the instrument.



CAUTION! When transporting the instrument, warranty claims are void if improper packing results in damage to the instrument.

To unpack the instrument:

1. Check the box for damage that occurred during transportation. Inform the supplier immediately and keep the damaged packaging.
-



CAUTION! Keep the box upright. Do not tip or tilt the box or place it on its side.

2. With the box facing up as indicated, open the side of the box labeled **Open Here**.



3. Grasp the handle on the cardboard and slide the instrument out of the box.

 **Tip:** Have a second person hold the box in place while you slide the instrument out on the cardboard.

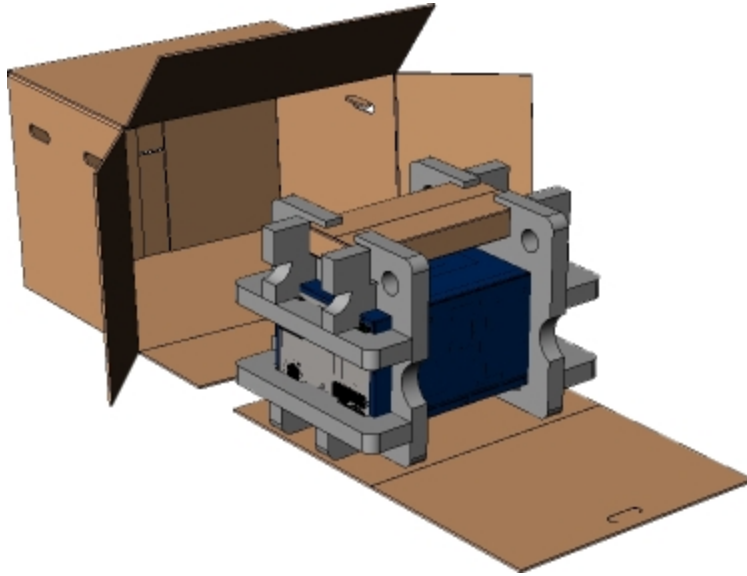

4. Remove the accessories toolbox.

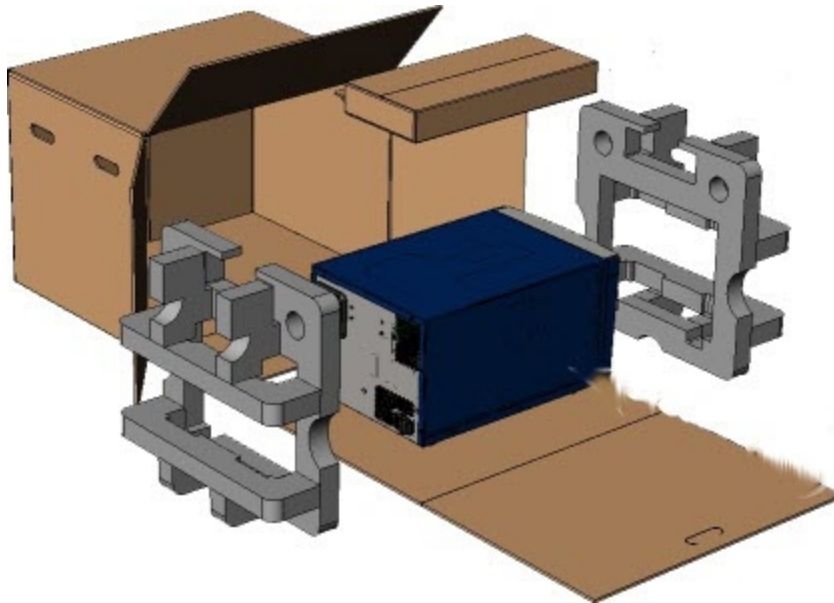

5. Remove the foam packaging and the plastic bag.
6. With one person on each end, place the instrument on a dry, flat area.

 **Note:** The feet are sticky and the instrument does not slide well. It can mark the work surface if slid.

Removing Transport Locks

CAUTION! The instrument can be damaged if you do not remove the transport locks before you power on the instrument.

There are transport locks on the detection cartridge drawer and the plate drawer to protect the instrument from damage during shipping. You must remove the transport locks before you power on the instrument.



Note: If you install the SpectraMax MiniMax 300 Imaging Cytometer, leave the transport locks in place until after you attach the cytometer to the microplate reader. See [Setting Up the Cytometer on page 27](#).

Required Tool

Illustration	Part Number	Description
	YW 000 006	2.0 mm hex key



CAUTION! Do not touch or loosen screws or parts other than those specifically designated in the instructions. Doing so could cause misalignment and possibly void the warranty.



CAUTION! The front cover is held onto the front of the instrument by powerful magnets. Keep magnetic storage devices or strips, such as hard drives, key cards, and credit cards, away from the instrument covers.

To remove the transport locks:

1. Firmly pull on the front cover from the bottom to remove it. The front cover is held in place by magnets.

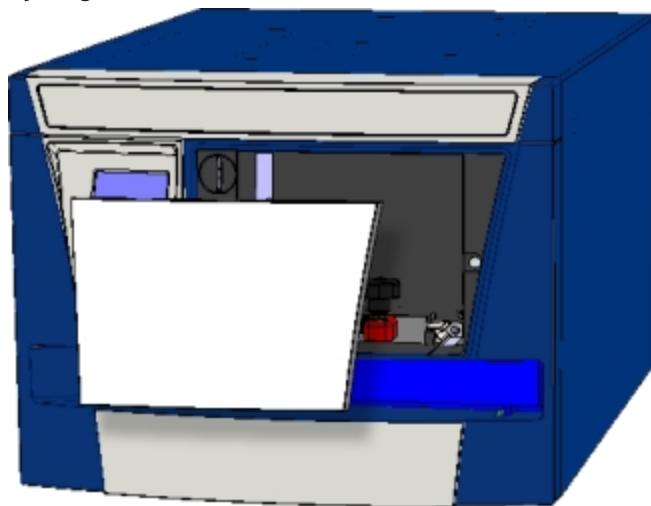

2. Turn the knob on the detection cartridge drawer transport lock counter-clockwise until it is free of the hole in the floor of the drawer compartment.

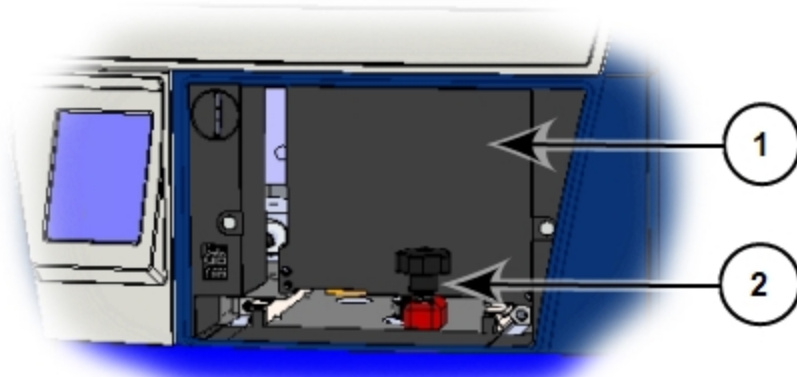

Item	Description
1	Detection cartridge drawer
2	Detection cartridge drawer transport lock

3. Slide the detection cartridge drawer forward until it is outside of the instrument.
4. Lower the detection cartridge drawer transport lock to remove it from the detection cartridge drawer. Store the transport lock in the accessories tool box.
5. Push the detection cartridge drawer back inside the instrument.
6. Align the magnets on the inside of the front cover with the magnets on the instrument base to replace the front cover.

7. Gently pull the yellow tab that protrudes from the plate chamber door to open the door. Hold the door (5) open while you remove the transport lock.



Note: Do not tear the yellow tab. It remains attached to the transport lock to make it easier to open the plate chamber door.

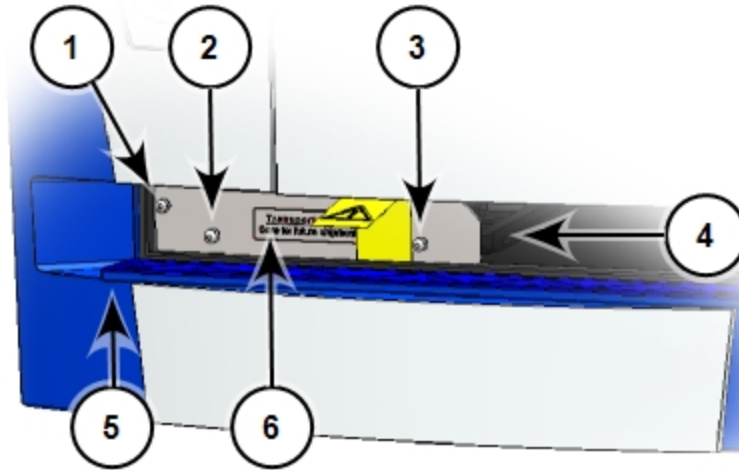

Item	Description
1	Screw #1 fastens the lock to the internal frame of the instrument
2	Screw #2 fastens the lock to the plate drawer
3	Screw #3 fastens the lock to the plate drawer
4	Plate drawer
5	Plate chamber door in open position
6	Plate drawer transport lock

8. Use the 2.0 mm hex key to loosen screw #1 in the upper-left corner of the transport lock until the lock disconnects from the instrument frame. The screw has a retaining washer to prevent removal from the lock.



Tip: After you loosen screw #1, pull the plate drawer slightly out of the instrument to hold the chamber door open.

9. Loosen screws #2 and #3 until the lock comes free of the plate drawer and you can remove the lock from the instrument. The screws have retaining washers that prevent removal from the lock. Store the transport lock in the accessories tool box.
10. Push the plate drawer back inside the instrument and close the chamber door.
11. Save the carton, foam inserts, accessories tool box, and transport locks for future shipments.

Connecting Instrument Cables

The power cord and USB cable connect to the ports on the rear of the instrument.



Note: If you install the SpectraMax MiniMax 300 Imaging Cytometer, do not use this procedure. See [Setting Up the Cytometer on page 27](#).

Illustration	Part Number	Description
	VZ 000 014	USB computer connection cable, 3 meter (9.8 foot)
	4400-0002 or 4400-0036	Power cord, 1 meter (3.3 foot)

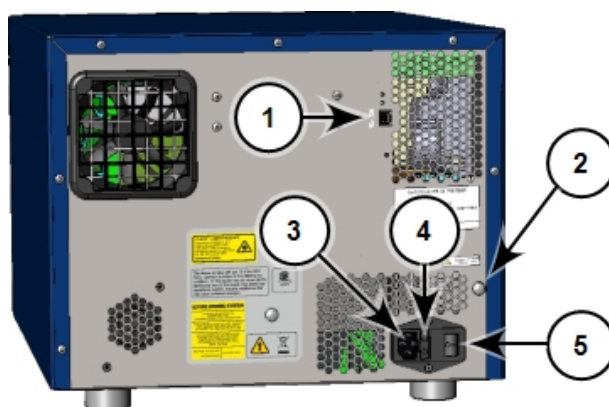

Item	Description
1	USB port
2	Gas inlet quick connect fitting
3	Power port
4	Fuse carrier
5	Power switch

To connect the instrument cables:

1. Make sure that the power switch on the rear of the instrument is in the Off position. See [Getting Started on page 41](#).
2. Connect one end of the supplied USB cable to a USB ports on the computer and then connect the other end to the USB port (1) on the rear of the instrument.
3. Connect the supplied power cord to the power port on the rear of the instrument and then connect the other end of the power cord to a grounded electrical wall outlet.

Connecting Gas Supply

You can connect a gas supply such as a CO₂, nitrogen, or other gas supply to the instrument. The instrument and the SoftMax Pro Software do not regulate the gas supply.

Part Number	Description
Not available from Molecular Devices	Polyurethane tubing, outside diameter = 4.0 mm
Not applicable	Flat head screwdriver
S MS 135 100	Gas inlet unlock tool (not provided with the instrument)

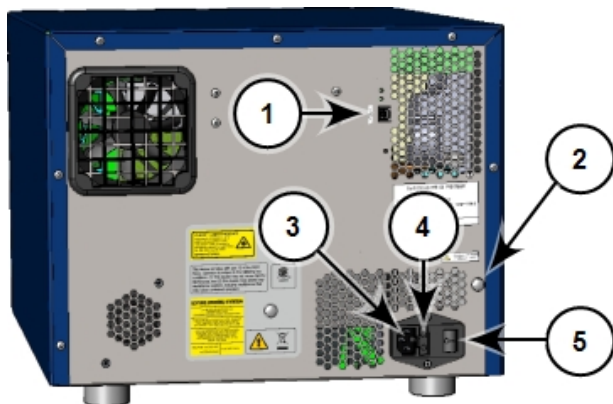

Item	Description
1	USB port
2	Gas inlet quick connect fitting
3	Power port
4	Fuse carrier
5	Power switch



WARNING! Use a compressed gas supply in a well-ventilated area. The instrument is not air-tight. Gas can escape into the atmosphere surrounding the instrument. When you use potentially toxic gas, observe the cautionary procedures your safety officer defines to maintain a safe work environment.

To connect a gas supply:

1. Power off the instrument.
2. Use a flat head screwdriver to pry off the small black cap on the rear of the instrument along the right edge to access the quick connect fitting. Save the cap for later use.
3. Connect one end of the tubing to the quick connect fitting and connect the other end to the gas supply.
4. Adjust the gas supply input pressure.



Note: For the maximum permitted air supply pressure for the gas inlet and polyurethane tubing specifications, see [Instrument Specifications on page 165](#).

To disconnect the polyurethane tubing:

1. Power off the instrument.
2. Turn off the gas supply at the source and wait a sufficient time for the pressure to dissipate.
3. Use the gas inlet unlock tool to press the quick connect fitting and release the tubing.



Note: The gas inlet unlock tool is not supplied with the instrument.

4. Remove the tubing from the quick connect fitting.
5. Replace the black cap over the quick connect fitting.



You can attach the SpectraMax MiniMax 300 Imaging Cytometer to the bottom of the SpectraMax i3x to add imaging capability to visually inspect your sample and to run cell-based assays at cellular or whole-cell resolution. The cytometer uses solid-state illumination, a digital camera, a 4x objective lens, laser auto-focus, and auto-exposure to capture fluorescent or label-free images of a sample at the bottom of the plate wells. The cytometer supports 96-well and 384-well, flat-bottom, clear-bottom plates.

The cytometer can use transmitted light and two fluorescent channels during the same plate read to acquire image data. You can select the channels for the acquisition. The StainFree Cell Detection Algorithm uses proprietary transmitted light analysis technology to eliminate cell staining for cell counting and confluency measurements.

The SpectraMax Transmitted Light (TL) detection cartridge enables you to do brightfield transmitted-light imaging. See [Imaging - Transmitted Light Detection Cartridge on page 62](#).

Whole-Cell Imaging

Whole-cell imaging assays are cell-based, or object-based, rather than the single-point measurements found in other types of plate reads. These types of assays can yield more biologically meaningful results that can discriminate the fluorescence related to objects, such as cells or beads, from the bulk solution within a plate well.

The measurement is primarily fluorescent with quantification of cell size, shape, area, and intensity. Label-free quantification is also supported through brightfield, transmitted light imaging. The camera resolution in the SpectraMax MiniMax 300 Imaging Cytometer is sufficient to determine the approximate shape of small 8 micron objects, such as blood cells. See [Imaging Read Mode on page 133](#).

Setting Up the Cytometer

The SpectraMax MiniMax 300 Imaging Cytometer attaches to the bottom of the SpectraMax i3x.

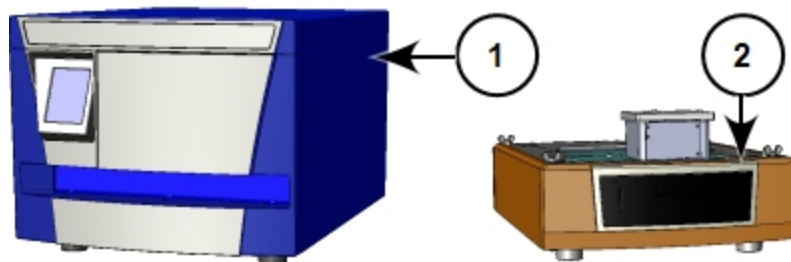

Item	Description
1	SpectraMax i3x (microplate reader)
2	SpectraMax MiniMax 300 Imaging Cytometer (cytometer)



Note: If you install the SpectraMax i3x at the same time as the cytometer, unpack the microplate reader before you set up the cytometer, but leave the microplate reader transport locks in place until after you attach the cytometer to the microplate reader. See [Setting Up the SpectraMax i3x Multi-Mode Microplate Reader on page 17](#).

Install SoftMax Pro Software

The SpectraMax MiniMax 300 Imaging Cytometer ships with a computer that meets greater minimum computer system specifications than those required for the standard installation of the SoftMax Pro Software. You must use the supplied computer as the acquisition computer that you connect to the instrument. You must install the SoftMax Pro Software - MiniMax Imaging Edition to run the SpectraMax MiniMax 300 Imaging Cytometer. Use of the SpectraMax MiniMax 300 Imaging Cytometer does not support the SoftMax Pro Software - GxP edition.



Note: Do not start the software until after you connect the cables and power supply to the instrument. You may need to install USB drivers before you start the software.

Computer Settings

To prevent data loss, turn off all sleep and hibernation settings for the hard disk, the CPU, and the USB ports.

To define computer settings in the Windows Control Panel:

1. Open **Control Panel**.
2. Click **Hardware and Sound**.
3. Under **Power Options**, click **Change When the Computer Sleeps**.
4. Click **Change advanced power settings**.
5. In the Power Options dialog, set **Hard disk > Turn Off Hard Disk After** to **Never**.
6. Set **Sleep > Sleep After** to **Never**.
7. Set **Sleep > Hibernate After** to **Never**.
8. Set **USB Settings > USB Selective Suspend Setting** to **Disabled**.
9. Click **OK**.

Optimizing the Computer for Image Acquisition

Acquiring images requires a large portion of computer memory and resources. When the software has limited access to computer memory and resources, image acquisition can take a long time. In some cases, images of some of the wells can be lost. Turn off all other programs to minimize the demands on computer memory and resources.

Before you start an image acquisition, save the protocol to a .txt file format, in a location with enough capacity for the image files. For best results, save Imaging mode files on the secondary hard drive inside the computer. If you use Auto Save to save multiple Imaging mode documents, the software saves each new document without the folders required to save images and analysis results.











Note: Use of an external hard drive can slow the data acquisition and is not recommended. Use of a USB flash drive or saving to a network location is not supported.

When you create a document for an Imaging mode experiment or a Western Blot experiment, the software creates a folder with the same name as the document. Each image file can be larger than 2 megabytes. The software can generate 300 megabytes of image data when you acquire the image of a single site in each well of a 96-well plate. A 384-well plate can generate 1 gigabyte of image data. When you acquire images of multiple sites, you increase the data storage requirement.

Cytometer Package Contents

The package contains the imaging cytometer and the accessories required to install the instrument.

Illustration	Part Number	Description
SoftMax Pro Software	Latest version	SoftMax Pro Software installation guide with Product Key
	Not applicable	Foam pad from the shipping container
	5024094	2.5 mm hex key
	5025413	3.0 mm hex key
	5024986	2 Laser-interlock brackets with 4 machine screws
	17-100-0010	Flat head screwdriver
	5018965	USB interconnection cable, 0.9 meter (3 foot)
	5025874	2 USB cables, 2 meter (6.6 foot)
	5022671	SpectraMax i3 Platform Transmitted Light (TL) detection cartridge

The SpectraMax MiniMax 300 Imaging Cytometer is operated by a computer that has rigid specifications. Molecular Devices provides this computer. The computer ships in separate package.

Unpacking the Cytometer

The package is designed to protect the instrument during transportation.



WARNING! LIFTING HAZARD. To prevent injury, use a minimum of two people to lift the instrument.



Note: Retain the shipping box and all packaging materials for future transport needs. Do not use tools that can damage the packaging or the instrument.



CAUTION! When transporting the instrument, warranty claims are void if improper packing results in damage to the instrument.

To unpack the cytometer:

1. Inspect the box for damage that occurred during transportation. Inform the supplier immediately and keep the damaged packaging.
 2. With the box facing up as indicated on the packaging, cut open the top of the box.
 3. Remove the top layer of packaging foam. You will use this piece of foam during the installation process.
 4. Remove the next layer of packaging foam that holds the tools and accessories.
-



CAUTION! Keep the instrument upright. Do not tip or shake the instrument to prevent damage to the moving components inside the instrument.

5. With one person on each end, lift the instrument out of the box and place the instrument on a flat area.
6. Remove the plastic bags from the instrument.

Removing Shipping Protections

To prevent damage during shipping, four wing nuts secure the bolts in the corners, a transport bracket with six blue retaining screws and three more blue retaining screws secure the optics plate on the top of the cytometer, and a cover with three blue retaining screws protects the optical components in the optics tower.

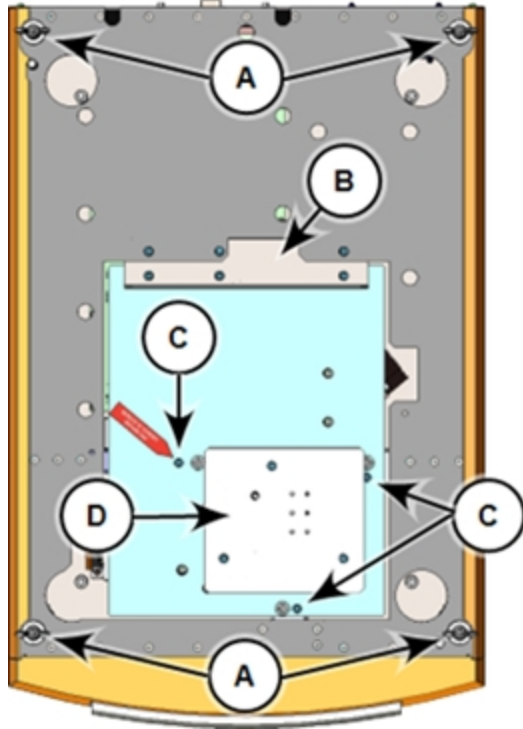

Optics Protection for Shipment	Description
A	4 Wing nuts and bolts
B	6 Transport bracket and retaining screws
C	3 Optics plate retaining screws
D	3 Optics cover and retaining screws

CAUTION! Never touch the optic mirrors, lenses, filters, or cables. The optics are extremely delicate, and critical to the function of the instrument.

Required Tool	Part Number	Description
	5025413	3.0 mm hex key

To remove the shipping protections from the cytometer:

1. Use your hand to remove the four wing nuts (A) from the bolts attached to the corners of the instrument. Do not remove the bolts.
2. Use the 3.0 mm hex key to remove the six blue retaining screws that secure the transport bracket (B) to the instrument.
3. Remove the transport bracket and store the retaining screws in the bag that held the 3.0 mm hex key.
4. Press down firmly on the optics plate and use the 3.0 mm hex key to remove the three blue retaining screws (C).



CAUTION! Maintain firm downward pressure on the optics plate until you remove all the screws are removed. When you remove the last screw, the optics plate might "pop" into position.

5. Gently remove pressure from the optics plate to let the springs below the plate extend.
6. Store the optics plate retaining screws in the bag that held the 3.0 mm hex key.
7. Use the 3.0 mm hex key to remove the three blue retaining screws (E) that secure the optics cover (D) to the optics tower.

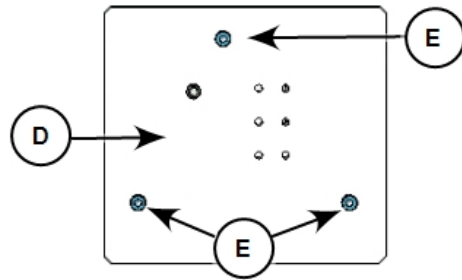

Optics Cover (top view)	Description
D	Optics cover
E	3 Optics cover retaining screws

8. Store the 3.0 mm hex key and the retaining screws in the bag that held the 3.0 mm hex key.
9. Lift the cover straight up to remove it from the cytometer.
10. Store the transport bracket, the optics cover, and the bag with the 3.0 mm hex key and retaining screws in the cytometer shipping container.





Attaching the Cytometer to the Microplate Reader

Prepare a work area that is approximately 130 cm (51.2 in.) wide and 65 cm (25.6 in.) deep, preferably with access on all sides to lift the instruments.

The required vertical clearance for this procedure is 56 cm (22.0 in.).



WARNING! LIFTING HAZARD. To prevent injury, use a minimum of two people to lift the instrument.

Required Accessory	Part Number	Description
	Not applicable	Foam pad from the shipping container
	5024094	2.5 mm hex key
	5024986	2 Laser interlock brackets with 4 screws
	17-100-0010	Screwdriver



Note: Retain all packaging materials, including the optics access cover and foam block for future transport needs. Do not use tools that can damage the packaging or the instrument.



CAUTION! When transporting the instrument, warranty claims are void if improper packing results in damage to the instrument.

To attach the cytometer to the microplate reader:

1. Place the foam pad from the shipping container on one side of the microplate reader.



CAUTION! If you used the SpectraMax i3x, remove all plates and detection cartridges from the instrument and install the transport locks on the plate drawer and detection cartridge drawer. See [Loading and Unloading Plates on page 45](#), [Removing Detection Cartridges on page 52](#), and [Installing Transport Locks on page 157](#).

2. Use two people to carefully place the microplate reader on its side on top of the foam pad.



WARNING! PINCH HAZARD. There is limited clearance between the side of the microplate reader and the work bench.

3. Use the 2.5 mm hex key to remove the four screws (G) that secure the optics access cover (F) to the bottom of the microplate reader.

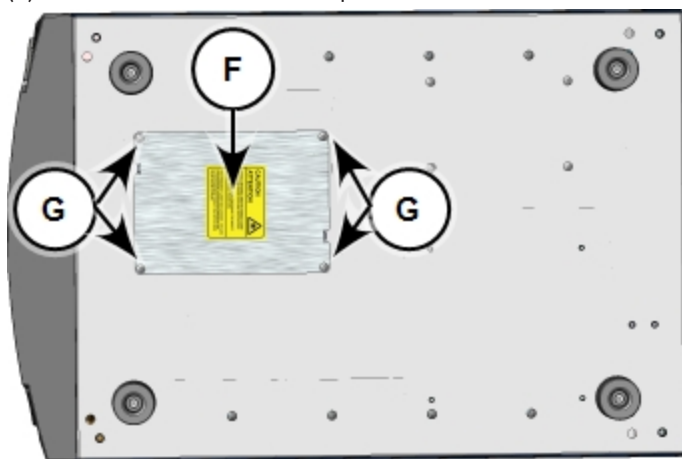

Optics Access Cover (Bottom of Microplate Reader)	Description
F	Optics access cover
G	4 Screws

4. Remove the optics access cover (F) from the microplate reader and store the optics access cover and screws in the cytometer shipping container.
5. Grasp the foam block in the optics access opening and then gently pull the foam block out. Store the foam block in the cytometer shipping container.

- Place one of the laser interlock brackets (H) over the optics access opening with the interlock tab (I) on the bracket inserted into the corresponding alignment slot (J) on the bottom of the microplate reader.

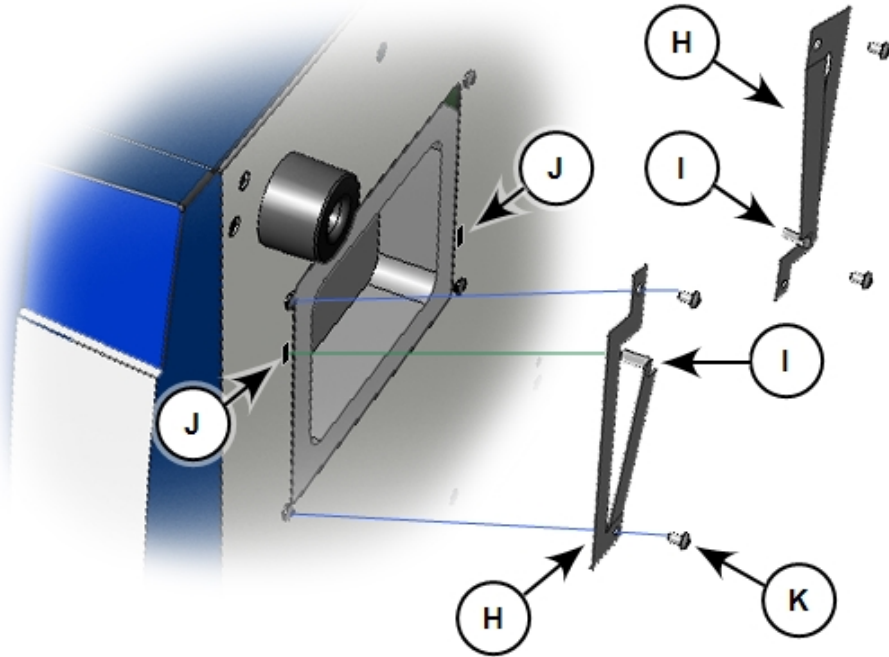

Laser Interlock Brackets	Description
H	2 Laser interlock brackets
I	2 Interlock tabs
J	2 Alignment slots
K	4 Screws

- Use the 2.5 mm hex key and two of the bracket screws (K) to secure the laser interlock bracket (H) to the bottom of the microplate reader.
- Attach the other laser interlock bracket (H) with the interlock tab (I) inserted into the corresponding alignment slot (J), and then use the other two screws (K) to secure the bracket to the bottom of the microplate reader.
- Lightly press on the interlock tabs (I) to make sure that they freely slide in and out of the alignment slots (J).



Note: The laser interlock brackets are part of the hardware interlock that prevents the laser module from turning on unless the cytometer is installed. For the interlocks to work properly, the interlock tabs must freely slide in and out of the alignment slots.

- Carefully place the cytometer on its side on the foam pad so that the top of the cytometer faces the bottom of the microplate reader.



Note: you might need to slide the microplate reader on the foam pad to make room for the cytometer.

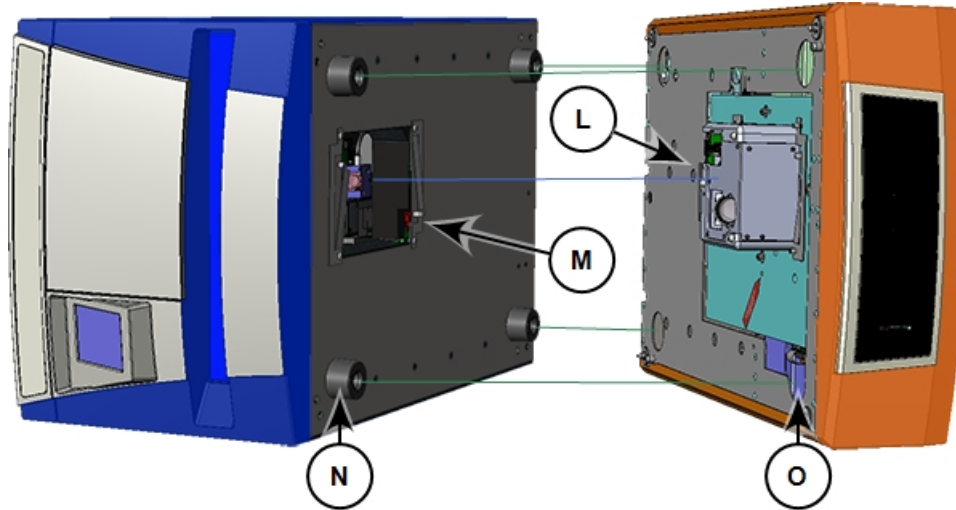

Item	Description
L	Optics tower
M	Optics access opening
N	4 Microplate reader feet
O	4 Microplate reader foot openings



WARNING! PINCH HAZARD. There is limited clearance between the bottom of the microplate reader and the top of the cytometer. The top of the cytometer is beveled to help provide clearance for fingers.

- Slide the cytometer into the microplate reader. Make sure that the optics tower (L) fits into the optics access opening (M) and the four feet (N) on the microplate reader fit into the four foot openings (O) on the cytometer.

12. Use a flat head screwdriver to tighten one of the four bolts on the bottom of the cytometer.



Note: You might need to use your free hand to push the cytometer into the reader to start the bolt and engage the threads.

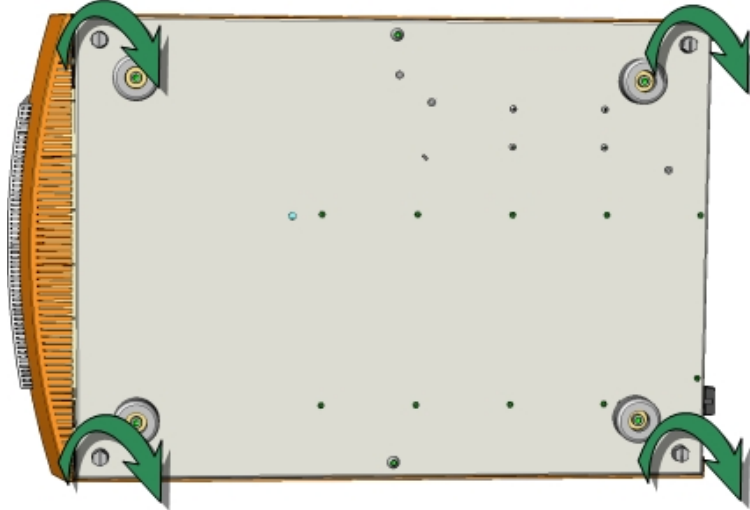

13. Attach the other three bolts to secure the cytometer to the microplate reader. Make sure that the bolts are properly seated on the bottom of the cytometer.

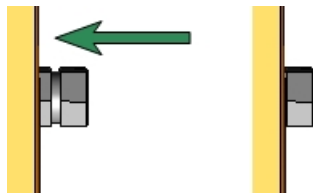



Properly Seated Bolt

14. Use two people to stand the combined microplate reader and cytometer in an upright position.
15. Store the packing materials, tools, optics-access cover, screws, and foam block in the cytometer shipping container.
16. Remove the transport locks from the SpectraMax i3x. See [Removing Transport Locks on page 20](#).

Connecting Instrument Cables

The power cord and USB cables connect the ports on the rear of the instruments to the computer and the power supply. Two USB cables connect from the cytometer to the computer. One controls the instrument and one controls the camera. A third USB cable connects the microplate reader to the cytometer.

Required Accessories	Part Number	Description
	5018965	USB interconnection cable, 0.9 meter (3 foot), provided with the cytometer
	5025874	2 USB computer connection cables, 2 meter (6.6 foot)
	VN 18S S01 or VN 18F F01 01	AC power cord, provided with the microplate reader

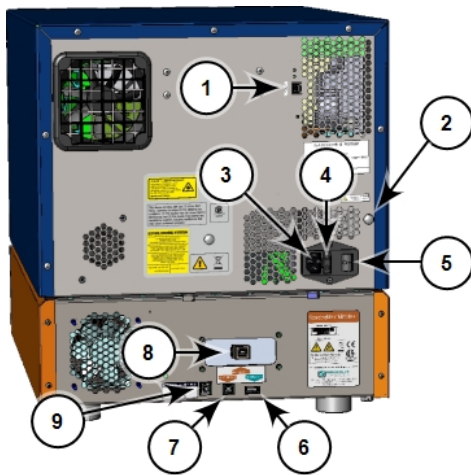

Item	Description
1	Microplate reader USB port
2	Gas inlet quick-connect fitting
3	Power port
4	Fuse carrier
5	Power switch
6	Interconnect USB port
7	Cytometer USB port 1
8	Cytometer USB port 2
9	Alternative power input for the SpectraMax i3x Multi-Mode Microplate Reader.

To connect the cytometer cables:

1. Place the instrument and the computer on a work area with sufficient space for the two devices and the required cables. To ensure sufficient ventilation and provide access to disconnect power from the instrument, maintain a 20 cm to 30 cm (7.9 in. to 11.8 in.) gap between the rear of the instrument and the wall.
2. Make sure that the power switch on the rear of the microplate reader is in the Off position.
3. Connect one end of the shorter USB cable (P) supplied with the cytometer to the interconnect USB port labeled **SpectraMax® System** (Q) on the rear of the cytometer, and then connect the other end of the USB cable to the microplate reader USB port (R) on the rear of the microplate reader.

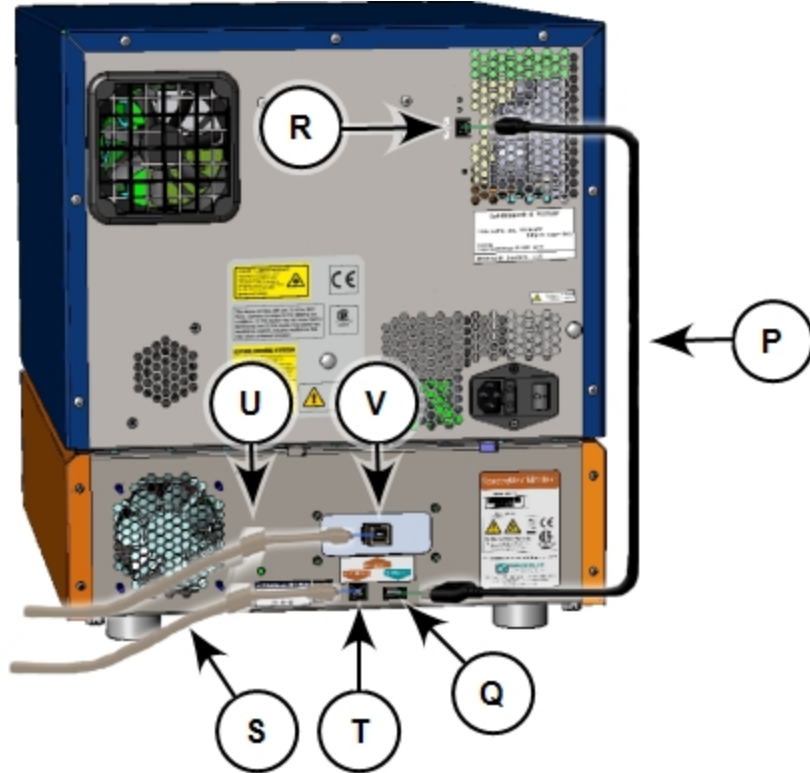

USB Connections	Description
P	USB interconnection cable, 0.9 meter (3 foot), provided with the cytometer
Q	Interconnect USB port
R	Microplate reader USB port
S	USB computer connection cable, 2 meter (6.6 foot), provided with the cytometer
T	Cytometer USB port 1
U	USB computer connection cable, 2 meter (6.6 foot), provided with the cytometer
V	Cytometer USB port 2

4. Connect one end of the 2 meter USB cable (S) supplied with the cytometer to the USB 3.0 port in the PCI card on the rear of the computer, and then connect the other end of the USB cable to the USB port labeled **COMPUTER USB 1 (T)** on the rear of the cytometer.



Note: You must use the 2 meter USB cables supplied with the cytometer to connect the instrument to the computer.

5. Connect one end of the 2 meter USB cable (U) supplied with the cytometer to the USB 3.0 port in the PCI card on the rear of the computer, and then connect the other end of the USB cable to the USB port labeled **COMPUTER USB 2 (V)** on the rear of the cytometer.



Note: The USB port labeled **COMPUTER USB 2** is the connection for the camera. It must be connected to a USB 3.0 port on the rear of the computer that is labeled for use with the SpectraMax MiniMax 300 Imaging Cytometer.

6. For the SpectraMax i3, connect the power supply to the cytometer port on the rear of the cytometer labeled **Alternative Power Input** and connect the other end to a wall outlet. The alternative power supply is not required for the SpectraMax i3x.
7. Set the power switch on the rear of the instrument to the On position and wait for the instrument to complete its initialization routine.
You might be prompted to install USB drivers, which must be done before you start the software.



CAUTION! The instrument can be damaged if the transport locks are not removed before you power on the instrument. See [Removing Transport Locks on page 20](#).

Calibrating the Cytometer

When you first install the SpectraMax MiniMax 300 Imaging Cytometer, the well image needs to be calibrated. This procedure can be done only by trained personnel.

The power switch and power connection are on the rear of the instrument.

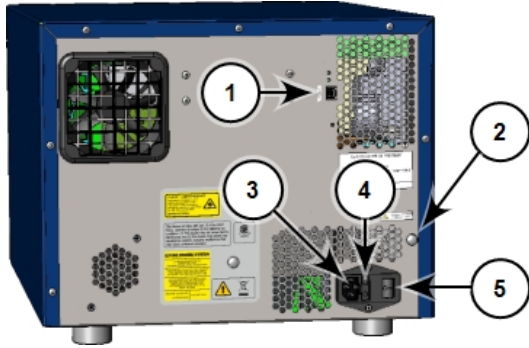

Item	Description
1	USB port
2	Gas inlet quick connect fitting
3	Power port
4	Fuse carrier
5	Power switch

To ensure sufficient ventilation and provide access to disconnect power from the instrument, maintain a 20 cm to 30 cm (7.9 in. to 11.8 in.) gap between the rear of the instrument and the wall. To turn the instrument on or off, press the power switch to place the rocker in the on or off position.

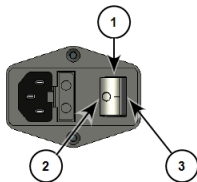

Item	Description
1	Power switch
2	Off
3	On

The SpectraMax MiniMax 300 Imaging Cytometer shares its power source with the SpectraMax i3x. To turn the cytometer on or off, use the power switch on the rear of the SpectraMax i3x. Before you connect or disconnect the power cord, make sure that the power switch on the rear of the microplate reader is in the Off position. After you power on the instrument you can start the SoftMax Pro Software and begin using the instrument.

Front Panel Controls and Indicators

The front panel of the SpectraMax i3x has a touchscreen that provides controls to open and close the detection cartridge drawer and the plate drawer. The touchscreen displays instrument information and enables you to set the plate chamber temperature and to define SpectraMax Injector cartridge settings.

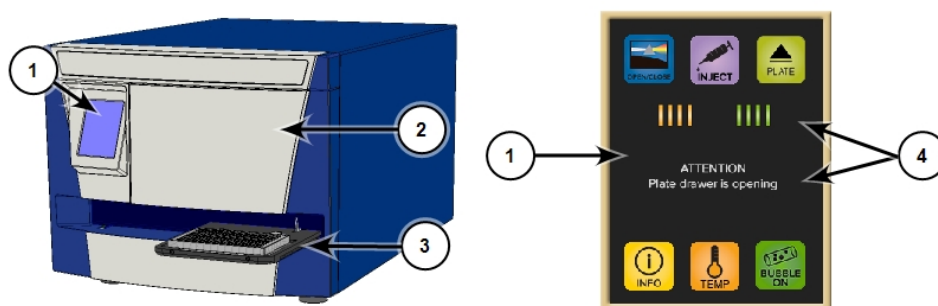

Item	Description
1	Touchscreen
2	Detection cartridge drawer
3	Plate drawer
4	Status indicators on the touch screen
5	Cytometer status LEDs

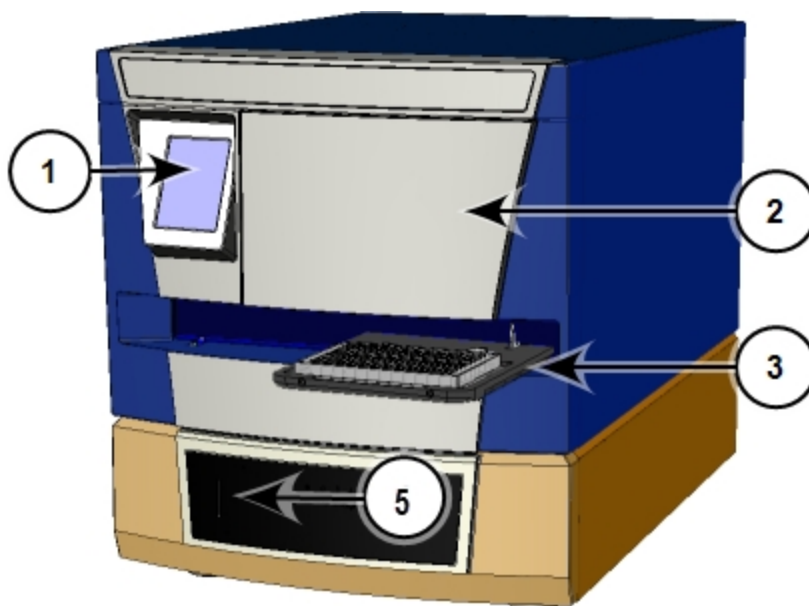







The front panel on the SpectraMax MiniMax 300 Imaging Cytometer has LED status indicators that provide information about the status of the cytometer.

Microplate Reader Touchscreen



The microplate reader touchscreen provides hardware controls to open and close the detection cartridge drawer and the plate drawer. You can also view information about the instrument, access the temperature controls, and access the controls for the SpectraMax Injector cartridge. The following buttons are on the instrument Home screen and Instrument Information screen.

Button	Description
	Touch to open or close the detection cartridge drawer. See Detection Cartridges on page 49 .
	Touch to open or close the detection cartridge drawer and to also view the SpectraMax Injector cartridge control screen. See SpectraMax Injector Cartridge on page 75 .
	Touch to open or close the plate drawer. See Loading and Unloading Plates on page 45 .
	Touch to view information about the instrument.
	Touch to view the temperature control screen. See Temperature Settings on page 48 .
	Touch to turn off bubble detection for the SpectraMax Injector cartridge. This button appears when you install the SpectraMax Injector cartridge. See Disabling Bubble Detection on page 97 .
	Touch on the Instrument Information screen to return to the Home screen.

Status Indicators

The microplate reader touchscreen displays information about the instrument status with color bars and text. The color bars are in groups of four and from left to right are red, orange, yellow, green, and blue. Some conditions display text below the color bars.

Color Bar Status Indicator	Instrument Status
Green bars that glow solidly	The instrument is in the ready state.
Orange bars that blink	The instrument is not ready due to an error during initialization. View the error message in the software.
Green bars that glow solidly, and orange bars that glow solidly or blink	The instrument is communicating with the software. Optics, drawers, or other mechanical items are moving within the instrument.
Red bars glowing solidly	The front panel is removed from the detection cartridge drawer or the plate chamber door is not closed properly.
All color bars that circulate horizontally	The instrument is doing a read operation.

The color and activity of the LED status indicators on the front of the cytometer provide information about cytometer status.

LED Indicator	Cytometer Status
Green LED glowing solidly	The cytometer is powered on and is ready to use.
Green LED blinking	The cytometer is powered on and initializing.
Red LED blinking	The cytometer is powered on but is not ready to use. This might indicate an error condition. View the error message in the software.
White LED flashing	The cytometer is imaging a plate using transmitted light. Each flash indicates an image acquisition.
Blue LED flashing	The cytometer is imaging a plate using fluorescence excitation. Each flash indicates an image acquisition.

Loading and Unloading Plates

To load or unload a plate:

1. On the microplate reader touchscreen, touch  to move the plate drawer outside of the instrument.
2. Place the plate on or remove it from the plate drawer.



Note: Place plates on the plate drawer in landscape orientation with well A1 in the left corner closest to the instrument.

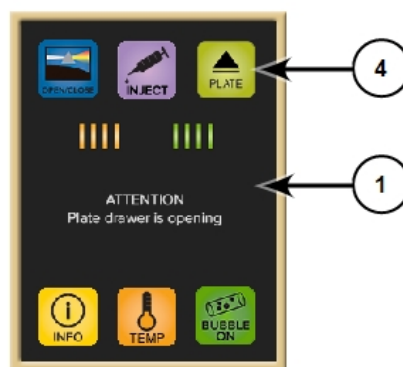
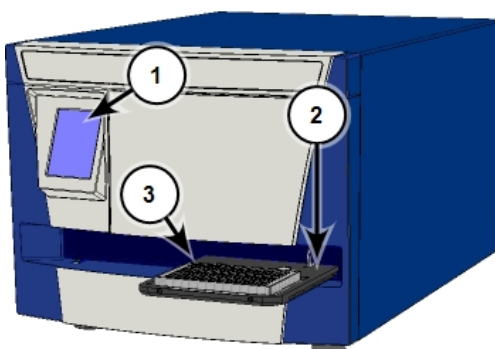

Item	Description
1	Touchscreen
2	Plate drawer
3	Well A1 on the plate
4	Plate drawer load/eject button on the touchscreen



3. Touch  to move the plate drawer inside the instrument.



CAUTION! To prevent damage to the instrument, set the plate height and read height accurately before you start a read. If the plate has a lid, you must select the Is Lidded check box in the Settings dialog and verify that the plate height with a lid is set accurately in the Plate Editor dialog before you start a read. See the *SoftMax Pro Data Acquisition and Analysis Software User Guide* or the application help.

Plate Recommendations

Depending on the application, the instrument can read 6, 12, 24, 48, 96, and 384-well plates and strip wells. For micro-volume measurements, the instrument supports SpectraDrop 24-well Low Volume Microplate and SpectraDrop 64-well Low Volume Microplate. The instrument is capable of reading 1536-well microplates when used with specific detection cartridges.

When you read optical density at wavelengths below 340 nm, you must use special UV-transparent, disposable, or quartz plates that permit transmission of the far UV spectra.

Top and bottom reads are available for fluorescence detection using the built in monochromator.



Note: For the SpectraMax i3x, you can use the detection cartridges for top reads.

The SoftMax Pro Software includes a plate list and you can use the software to define additional plate types with the manufacturer's specifications for well size, spacing, and distance from the plate edge.

The type of plate and the way you handle it can have an effect on the measurement performance of the instrument. Select a plate type with properties suited for the application and for use with multi-mode microplate readers.



CAUTION! To prevent damage to the instrument, the height of the plate must not exceed 17 mm, including the lid if the plate is lidded.

General plate handling guidelines:

- Never touch the clear well bottom of plates.
- Visually inspect the bottom and rim of the plate before use to make sure that they are free of dirt and contaminants.
- Keep unused plates clean and dry.
- Make sure that the strips on strip plates are inserted correctly and level with the frame.
- Do not use V-bottom plates unless the performance has been tested and validated with this instrument. Irregular plastic density in the tip of the well can cause inaccurate measurements.



CAUTION! To prevent damage to the instrument, set the plate height and read height accurately before you start a read. If the plate has a lid, you must select the *Is Lidded* check box in the Settings dialog and verify that the plate height with a lid is set accurately in the Plate Editor dialog before you start a read. See the *SoftMax Pro Data Acquisition and Analysis Software User Guide* or the application help.

Cytometer Plate Recommendations

For the SpectraMax MiniMax 300 Imaging Cytometer, you can use either 96-well or 384-well plates that are designated for imaging. The following table lists the plate selection guidelines for the SpectraMax MiniMax 300 Imaging Cytometer.

Read Mode	Plate Type	Other Considerations
Fluorescent Imaging	Flat bottom, clear bottom, black wall	When an application specifies a surface treatment, use only plates with the correct treatment.
Transmitted-Light Imaging	Flat bottom, clear bottom	For best results with transmitted-light reads, use a plate with no cover. You can use a clear cover, if required. When an application specifies a surface treatment, use only plates with the correct treatment.



Note: The cytometer captures images from the bottom of each plate well. Plates must have flat-bottom, clear-bottom wells. For optimal results, you should use plates with a bottom thickness of less than 600 μm .

The following clear-bottom, black-wall plates have been tested for use with the SpectraMax MiniMax 300 Imaging Cytometer.

- 96-well BD Biocoat Collagen (part number: 356649)
- 96-well Costar (part number: 3603)
- 96-well Greiner (part number: 655090)
- 384-well BD Biocoat Collagen (part number: 354667)
- 384-well Costar (part number: 3712)
- 384-well Greiner (part number: 781091)

Temperature Settings







The microplate reader touchscreen enables you to set and control the temperature of the plate chamber. The instrument can maintain the temperature inside the plate chamber at 4°C (7.2°F) above ambient to 45°C (113°F). You can also use the SoftMax Pro Software to control the temperature of the plate chamber. See the *SoftMax Pro Data Acquisition and Analysis Software User Guide* or the application help.



Note: The instrument temperature sensors detect the temperature of the air inside the chamber, not the temperature of the samples in the plate. If you use the instrument to warm the samples, you should use a seal or lid on the plate to prevent evaporation of the sample. A seal or lid helps to maintain uniform temperature. Letting the prepared sample equilibrate inside the plate chamber can take an hour or more. You can speed up equilibration by pre-warming the sample and the assay reagents before you place the plate in the chamber. Validate the data quality to determine whether the seal or lid can stay on the plate for the read.



To use the touchscreen to set the temperature:

1. On the Home screen, touch  to display the Temperature Settings screen. The Temperature Settings screen displays the current plate chamber temperature. If the target temperature is set to **On**, then the target temperature also displays.
2. Touch  and  to define the target temperature and then touch .
3. Touch  to turn off temperature control.
4. Touch  to return to the Home screen.

Detection Cartridges

The SpectraMax i3x supports user-installable detection cartridges to expand its read capabilities. Each detection cartridge contains the light source, optics, and electrical components needed to do specific read modes.

For information about the applications and read modes each detection cartridge enables, see [Detection Cartridges on page 53](#).

Application notes with specific application protocol suggestions are in the Information Center and Knowledge Base on the Molecular Devices web site at www.moleculardevices.com.

You install detection cartridges in the microplate reader detection cartridge drawer. The detection cartridge drawer has four slots and each detection cartridge occupies one or more slots. The rear most slot (slot 4) is for the SpectraMax Injector cartridge only. Installation and removal of a detection cartridge is the same regardless of the number of slots it occupies.

For the SpectraMax i3x, you can use the detection cartridges for top reads.



CAUTION! To prevent dust from collecting inside the instrument, the detection cartridge drawer should be open only for as long as necessary to install or remove detection cartridges. Keep the detection cartridge drawer closed whenever possible.

Installing Detection Cartridges

When you install a detection cartridge in the instrument, the SoftMax Pro Software detects the cartridge and displays the related data acquisition settings on the Settings dialog and enables the applicable read modes. You can install most detection cartridges into any of the first three slots in the detection cartridge drawer. The slot furthest to the rear (slot 4) is reserved for the SpectraMax Injector cartridge. To install the Injector Cartridge, see [Installing the Injector Cartridge on page 75](#).



Note: When you use the software in offline mode, all detection cartridges display on the Settings dialog.



CAUTION! To prevent damage to the installed detection cartridges and the instrument, do not manually slide the detection cartridge drawer in or out when the instrument is powered on or when one or more detection cartridges are installed in the drawer.

To install a detection cartridge:



1. On the microplate reader touchscreen, touch  to open the detection cartridge drawer.

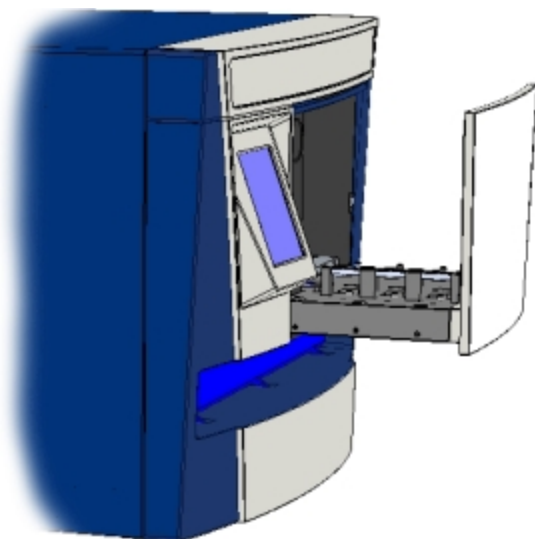

2. Remove the red cap from the detection cartridge.
3. Position the two small holes and the connector pins on the detection cartridge over the holder pins and connector for the detection cartridge slot.



Note: Some detection cartridges occupy more than one slot.

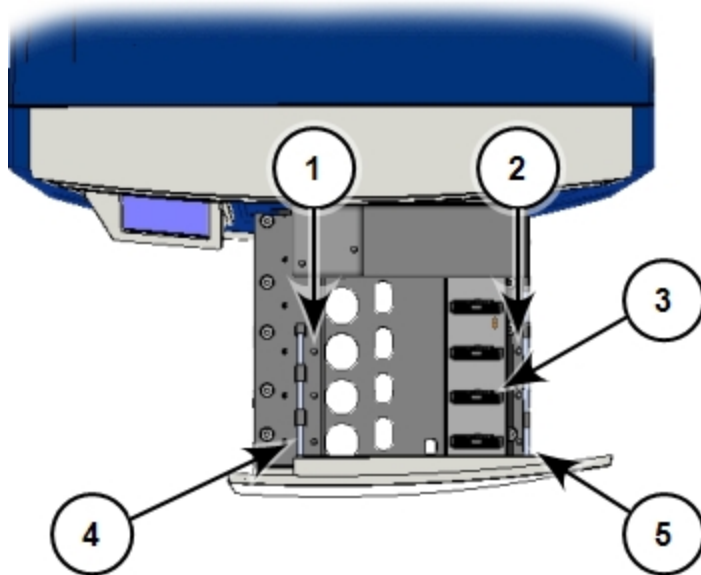

Item	Detection Cartridge Drawer Top View
1	Holder pin
2	Holder pin
3	Detection cartridge connector
4	Retaining rod
5	Retaining rod

4. Gently but firmly push the detection cartridge onto the holder pins and connector so that the detection cartridge is fully seated in the detection cartridge slot.
5. Push the two retaining clips on either side of the detection cartridge so that they fasten securely to the retaining rods on both sides of the detection cartridge drawer.



Note: Detection cartridges that occupy more than one slot have two retaining clips on each side. Securely fasten all retaining clips to the retaining rods on both sides of the detection cartridge drawer.

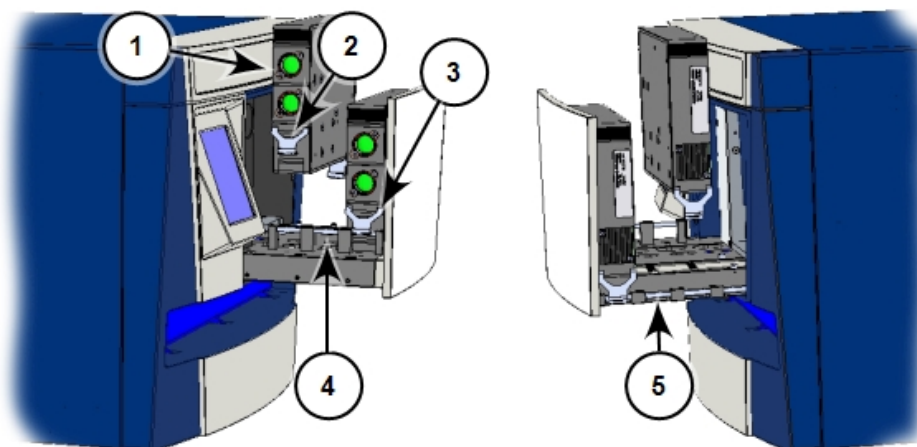

Item	Detection Cartridge Retaining Clips and Retaining Rods
1	Detection cartridge
2	Retaining clip unattached
3	Retaining clip attached
4	Retaining rod
5	Retaining rod



6. Touch  to close the detection cartridge drawer.
7. Start the SoftMax Pro Software and connect to the instrument.
If the software is running and connected to the instrument, select the Operations tab and click **Refresh** to let the software detect the detection cartridges.

Removing Detection Cartridges

You do not need to remove a detection cartridge when it is not in use. You must remove detection cartridges when you pack the instrument for shipment. Store each detection cartridge in the box in which it was shipped in a dry, dust-free, controlled environment.

To remove a detection cartridge from the instrument:



CAUTION! To prevent damage to the installed detection cartridges and the instrument, do not manually slide the detection cartridge drawer in or out when the instrument is powered on or when one or more detection cartridges are installed in the drawer.

1. On the microplate reader touchscreen, touch  .

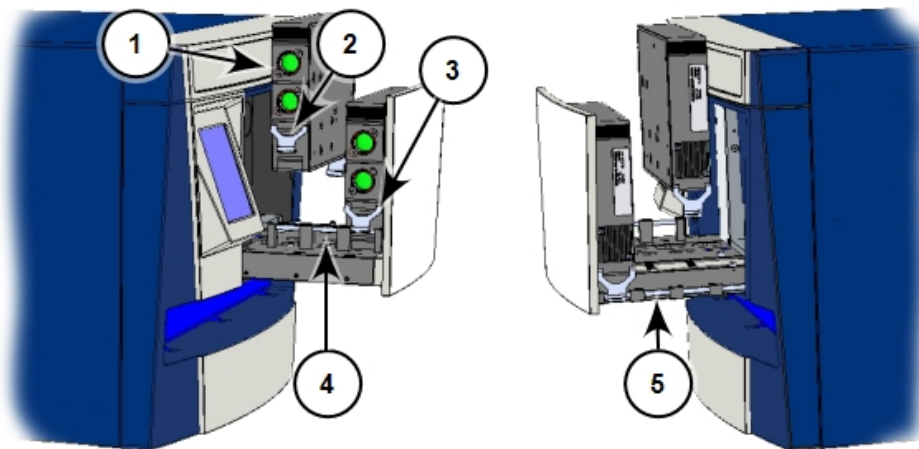

Item	Detection Cartridge Retaining Clips and Retaining Rods
1	Detection cartridge
2	Retaining clip unattached
3	Retaining clip attached
4	Retaining rod
5	Retaining rod

2. Place the end of a flat head screwdriver in the slot on the retaining clip and use it as a lever to unfasten the retaining clips on both sides of the detection cartridge.



Note: Detection cartridges that occupy more than one slot have two retaining clips on each side. Unfasten all retaining clips from the retaining rods.

3. Lift the detection cartridge straight up off of the connector and holder pins on the detection cartridge slot.
4. Place the red cap on the detection cartridge.



5. Touch  to close the detection cartridge drawer.

The SpectraMax i3x supports user-installable detection cartridges to expand its read capabilities. Each detection cartridge contains the light source, optics, and electrical components needed to do specific read modes.



Note: You can use the detection cartridges for top reads only.

Application notes with specific application protocol suggestions are in the Information Center and Knowledge Base on the Molecular Devices web site at www.moleculardevices.com.

For information about detection cartridges, see the following topics:

- [AlphaScreen Detection Cartridges, see page 54](#)
- [Fluorescence Intensity Detection Cartridges, see page 56](#)
- [Fluorescence Polarization Detection Cartridges, see page 59](#)
- [FRET Detection Cartridges on page 61](#)
- [Imaging - Transmitted Light Detection Cartridge on page 62 \(For use with the SpectraMax MiniMax 300 Imaging Cytometer\)](#)
- [Luminescence Detection Cartridges, see page 64](#)
- [ScanLater Western Blot Detection Cartridge on page 68](#)
- [SpectraMax Injector Cartridge on page 75](#)
- [Time Resolved Fluorescence Detection Cartridges, see page 71](#)

Contact Molecular Devices to have custom detection cartridges designed to meet the specific needs of your application.

AlphaScreen Detection Cartridges

There are three AlphaScreen® Detection Cartridges that use a 680 nm laser diode to provide a sensitive read system for AlphaScreen assays. The design isolates each well and provides the optimal performance for AlphaScreen assays. These cartridges also capture the Europium emission line of AlphaLISA®.

The following AlphaScreen detection cartridges are available:

- AlphaScreen 384 Std Detection Cartridge
- AlphaScreen 384 HTS Detection Cartridge
- AlphaScreen 1536 HTS Detection Cartridge

Each cartridge occupies one slot in the cartridge drawer.

These cartridges support the following read types:

- [Endpoint Read Type, see page 114](#)
- [Kinetic Read Type, see page 114](#)
- [Well Scan Read Type, see page 115](#)

ALPHASCREEN and ALPHALISA are registered trademarks of PerkinElmer, Inc.

AlphaScreen

ALPHA stands for Amplified Luminescent Proximity Homogeneous Assay. AlphaScreen is a bead-based chemistry used to study molecular interactions between moieties A and B, for example. When a biological interaction between A and B moves beads—coated with A and B, respectively—together, a cascade of chemical reactions produce a greatly amplified signal.

An AlphaScreen measurement includes a light pulse, by turning on the laser diode for a specified time, turning off the laser diode, followed by the measurement of the AlphaScreen signal, as specified in the protocol parameters.

AlphaScreen HTS Timing Parameters

Parameter	Value	Comment
Excitation time	40 ms	The period when the sample is exposed to the laser.
Integration time	80 ms	The period when the signal is read from the sample.

Plate Recommendations

Plate Recommendations for the AlphaScreen Detection Cartridge

Read Mode	Plate Type	Other Considerations
AlphaScreen (ALPHA)	Solid white	When an application specifies a surface treatment, use only plates with the correct treatment. You should use white plates to read AlphaScreen (such as, Optiplate-384 white opaque, Perkin Elmer #6007290). Black plates absorb light and lead to reduced signals.

Measurement Specifications

Measurement Specifications for the AlphaScreen Detection Cartridges

Item	Description	Description	Description
Detection Cartridge Name	AlphaScreen 384 Std Detection Cartridge	AlphaScreen 384 HTS Detection Cartridge	AlphaScreen 1536 HTS Detection Cartridge
Short Name	ALPHA 384 Std	ALPHA 384 HTS	ALPHA 1536 HTS
Part Number	0200-7017	0200-7018	0200-7019
Weight	1.5 lbs (0.7 kg)	1.5 lbs (0.7 kg)	1.5 lbs (0.7 kg)
Plate Formats	Compatible with 6, 12, 24, 48, 96, and 384-well plates.	Compatible with 6, 12, 24, 48, 96, and 384-well plates.	Compatible with 6, 12, 24, 48, 96, 384, and 1536-well plates.
Read Mode	AlphaScreen	AlphaScreen	AlphaScreen
Type	Single emission	Single emission	Single emission
Number of Slots	1 slot	1	1
Light Source	Laser diode (1 watt)	Laser diode (1 watt)	Laser diode (1 watt)
Filter Set	EX: 680 EM: 570-100	EX: 680 EM: 570-100	EX: 680 EM: 570-100
Labels	AlphaScreen and AlphaLISA reagents and assay kits	AlphaScreen and AlhpLISA reagents and assay kits	AlphaScreen and AlphaLISA reagents and assay kits
Detection Limit*	384-well (25 µl) <100 amol/well	384-well (25 µl) <100 amol/well	NA

*AlphaScreen detection limit <100 amol of biotinylated-LCK-P peptide, 25 µL/well in 384-well plate. AlphaScreen detection limit of biotinylated-LCK-P peptide was determined with 3 x SD over background method using AlphaScreen Phosphotyrosine (PT66) Assay Kit from Perkin Elmer (Cat. No. 6760602C). Serial dilutions were made into assay buffer by diluting 10 nM b-LCK-P reaction mix that contains Acceptor and Donor beads. Measurement was done after a 1 hour incubation.

Fluorescence Intensity Detection Cartridges

The following Fluorescence Intensity (FI) detection cartridges use an ultra-high power LED for the excitation of various fluorescent labels for the fluorescence intensity read mode. The standard dual-emission design provides simple, straightforward fluorescence resonance energy transfer (FRET) measurement. These cartridges occupy one slot in the cartridge drawer.

- Fluorescence Intensity (FI) (coum-fluor) Detection Cartridge
- Fluorescence Intensity (FI) (fluor-rhod) Detection Cartridge
- Fluorescence Intensity (FI) (Cy3-Cy5) Detection Cartridge
- Fluorescence Intensity (FI) (Cfp-Yfp) Detection Cartridge

Fluorescence Intensity (FI) GeneBLAzer Detection Cartridge

The Fluorescence Intensity (FI) GeneBLAzer detection cartridge is designed for use with GeneBLAzer assays from Invitrogen. The standard dual-emission design provides Fluorescence Resonance Energy Transfer (FRET) measurement. This cartridge occupies one slot in the cartridge drawer.

The cartridges listed above support the following read types:

- [Endpoint Read Type, see page 114](#)
- [Kinetic Read Type, see page 114](#)
- [Well Scan Read Type, see page 115](#)

Fluorescence Intensity

In Fluorescence Intensity read mode, the source light is directed through an excitation filter and then focused by an objective lens from above the plate. The filter passes only the specified wavelength band necessary to excite samples. The objective lens collects the resulting fluorescence and directs it through an emission filter to separate background light from the specific wavelengths generated by samples. This signal is detected by a photomultiplier tube.

The Fluorescence Intensity (FI) detection cartridges use an ultra-high power LED and an optimized filter set together with the photon counting detection capabilities of the instrument, resulting in superior detection limits and linear dynamic range at short read times.

Plate Recommendations

Plate Recommendations for the Fluorescence Intensity (FI) Detection Cartridges

Read Mode	Plate Type	Other Considerations
Fluorescence Intensity (FL)	Solid black	When an application specifies a surface treatment, use only plates with the correct treatment.

Measurement Specifications

Measurement Specifications for the Fluorescence Intensity (FI) Detection Cartridges

Item	Description	Description	Description
Detection Cartridge Name	Fluorescence Intensity (FI) (coum-fluor) Detection Cartridge	Fluorescence Intensity (FI) (fluor-rhod) Detection Cartridge	Fluorescence Intensity (FI) (Cy3-Cy5) Detection Cartridge
Short Name	FI-COFL	FI-FLRH	FI-CY3CY5
Part Number	0200-7002	0200-7003	0200-7004
Weight	1.5 lbs (0.7 kg)	1.5 lbs (0.7 kg)	1.5 lbs (0.7 kg)
Read Mode	Fluorescence Intensity (FL) Fluorescence Resonance Energy Transfer (FRET)	Fluorescence Intensity (FL) Fluorescence Resonance Energy Transfer (FRET)	Fluorescence Intensity (FL) Fluorescence Resonance Energy Transfer (FRET)
Type	Dual emission	Dual emission	Dual emission
Number of Slots	1 slot	1 slot	1 slot
Light Source	Ultra-high power LED	Ultra-high power LED	Ultra-high power LED
Filter Set	EX: 360-35 EM1: 465-35 EM2: 535-25	EX: 485-20 EM1: 535-25 EM2: 595-35	EX: 535-25 EM1: 595-35 EM2: LP655
Labels	FL: Coumarin FRET: Coumarin-Fluorescein	FL: Fluorescein FRET: Fluorescein-Rhodamine	FL: Rhodamine FRET: CY3-CY5
Detection Limit	384-well plate (75 μ L): 10 fmol/well 1536-well plate (8 μ L): 3 fmol/well	384-well plate (75 μ L): 0.10 fmol/well 1536-well plate (8 μ L): 0.03 fmol/well	384-well plate (75 μ L): 0.15 fmol/well 1536-well plate (8 μ L): 0.06 fmol/well
Linear Dynamic Range	4 logs in a single plate read	6 logs in a single plate read	6 logs in a single plate read

*Other labels compatible with the excitation and emission wavelengths of the cartridge can also be used. All trademarks are the property of their respective owner.

Measurement Specifications for the Fluorescence Intensity (FI) Detection Cartridges

Item	Description	Description
Detection Cartridge Name	Fluorescence Intensity (FI) (CFP-YFP) Detection Cartridge	Fluorescence Intensity (FI) Gene BLAzer Detection Cartridge
Short Name	FI-CFP-YFP	G-BLAZER
Part Number	0200-7005	0200-7006
Weight	1.5 lbs (0.7 kg)	1.5 lbs (0.7 kg)
Read Mode	Fluorescence Intensity (FL) Fluorescence Resonance Energy Transfer (FRET)	Fluorescence Intensity (FL) Fluorescence Resonance Energy Transfer (FRET)
Type	Dual emission	Dual emission
Number of Slots	1 slot	1 slot
Light Source	Ultra-high power LED	Ultra-high power LED
Filter Set	EX: 445-20 EM1: 485-20 EM2: 535-25	EX: 406-15 EM1: 465-35 EM2: 535-25
Labels	FL: AlexaFluor 430, Thioflavin FRET: CFP-YFP	FL: 7-hydroxycoumarin FRET: Coumarin-Fluorescein, CCF2 GeneBLAzer substrate Other labels compatible with the excitation and emission wavelengths of the cartridge can also be used.
Detection Limit	384-well plate (75 μ L): 5 fmol/well 1536-well plate (8 μ L): 5 fmol/well	
Linear Dynamic Range	5 logs in a single plate read	

Fluorescence Polarization Detection Cartridges

There are two Fluorescence Polarization (FP) detection cartridges that support the fluorescence polarization read mode for specific labels, depending on the cartridge. For best results you should use solid black plates.

- Fluorescence Polarization (FP) (Fluorescein) Detection Cartridge
- Fluorescence Polarization (FP) (Rhodamine) Detection Cartridge

Each cartridge occupies one slot in the cartridge drawer.

These cartridges support the following read types:

- [Endpoint Read Type, see page 114](#)
- [Kinetic Read Type, see page 114](#)

Fluorescence Polarization

Fluorescence Polarization (FP) read mode measures the relative change of polarization of emitted fluorescent compared to excitation light.

Fluorescence Polarization detection is based on Fluorescence Intensity, with the important difference that it uses plane-polarized light, rather than non-polarized light. Microplate readers measure the Fluorescence Polarization of the sample by detecting light emitted both parallel and perpendicular to the plane of excitation.

By using a fluorescent dye to label a small molecule, the binding of a small molecule to an interaction partner of equal or greater size can be monitored through its speed of rotation.

When molecules are excited with polarized light, the polarization of the emitted light depends on the size of the molecule to which the fluorophore is bound. Larger molecules emit a higher percentage of polarized light, while smaller molecules emit a lower percentage of polarized light because of their rapid molecular movement. For this reason, FP is generally used for molecular binding assays in high-throughput screening (HTS).

Plate Recommendations

Plate Recommendations for the Fluorescence Polarization (FP) Detection Cartridge

Read Mode	Plate Type	Other Considerations
Fluorescence Polarization (FP)	Solid black	When an application specifies a surface treatment, use only plates with the correct treatment. You should use unidded plates for fluorescence polarization measurements.

Measurement Specifications

Measurement Specifications for the Fluorescence Polarization (FP) Detection Cartridges

Item	Description	Description
Detection Cartridge Name	Fluorescence Polarization (FP) (Fluorescein) Detection Cartridge	Fluorescence Polarization (FP) (Rhodamine) Detection Cartridge
Short Name	FP-FLUO	FP-RHOD
Part Number	0200-7009	0200-7010
Weight	1.5 lbs (0.7 kg)	1.5 lbs (0.7 kg)
Read Mode	Fluorescence polarization (FP)	Fluorescence polarization (FP)
Type	Dual emission	Dual emission
Number of Slots	1 slot	1 slot
Light Source	Ultra-high power LED	Ultra-high power LED
Filter Set	EXP: 485-20 EMP1: 535-25 EMP2: 535-25	EXP: 535-25 EMP1: 595-35 EMP2: 595-35
Labels	Fluorescein 1 nM Other labels compatible with the excitation and emission wavelengths of the cartridge can also be used.	Rhodamine 4 nM Other labels compatible with the excitation and emission wavelengths of the cartridge can also be used.
Detection Limit ¹	384-well (75 µl): 4 mP 1536-well (8 µl): 6 mP	384-well (75 µl): 4 mP 1536-well (8 µl): 6 mP

¹ Replicate standard deviation at the label concentration specified under Labels.

FRET Detection Cartridges

The following detection cartridges use an ultra-high power LED for the excitation of various fluorescent labels. The standard dual-emission design provides simple, straightforward fluorescence resonance energy transfer (FRET) measurement. These cartridges occupy one slot in the cartridge drawer.

- Fluorescence Intensity (FI) (coum-fluor) Detection Cartridge
- Fluorescence Intensity (FI) (fluor-rhod) Detection Cartridge
- Fluorescence Intensity (FI) (Cy3-Cy5) Detection Cartridge
- Fluorescence Intensity (FI) (Cfp-Yfp) Detection Cartridge

Fluorescence Intensity (FI) GeneBLAzer Detection Cartridge

The Fluorescence Intensity (FI) GeneBLAzer detection cartridge is designed for use with GeneBLAzer assays from Invitrogen. The standard dual-emission design provides Fluorescence Resonance Energy Transfer (FRET) measurement. This cartridge occupies one slot in the cartridge drawer.

These cartridges support the following read types:

- [Endpoint Read Type, see page 114](#)
- [Kinetic Read Type, see page 114](#)
- [Well Scan Read Type, see page 115](#)

Imaging - Transmitted Light Detection Cartridge

The Transmitted Light (TL) detection cartridge provides white LED illumination to do brightfield, transmitted-light imaging when you use the SpectraMax MiniMax 300 Imaging Cytometer. The StainFree Cell Detection Algorithm uses proprietary transmitted light analysis technology to eliminate cell staining for cell counting and confluency measurements.

The cartridge occupies one slot in the cartridge drawer and supports the Imaging read mode.

Selecting the Light Source for Imaging

The SpectraMax MiniMax 300 Imaging Cytometer captures images from the bottom of each plate well. You can illuminate the sample with white transmitted light from the top of the plate when you use the Transmitted Light (TL) detection cartridge, or you can use fluorescent excitation from the bottom of the plate. See [Imaging - Transmitted Light Detection Cartridge](#) on page 62.

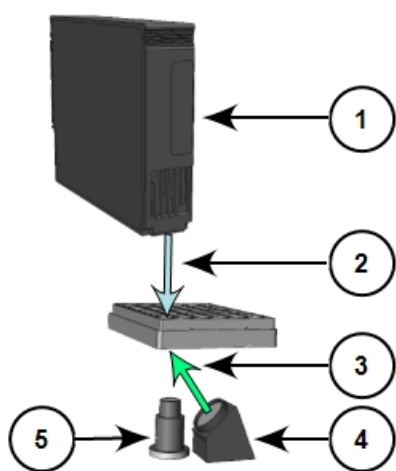

Path of Selected Light Sources

Item	Description
1	Transmitted Light (TL) detection cartridge
2	Path of white light from the Transmitted Light (TL) detection cartridge
3	Path of fluorescent excitation
4	Light source for fluorescent excitation
5	Camera lens

For best results with transmitted-light reads, use a plate with no cover. You can use a clear cover, if required. For Fluorescent reads, you can use a plate with a solid cover.

Measurement Specifications

Measurement Specifications for the Transmitted Light (TL) detection cartridge

Item	Description
Detection cartridge name	Transmitted Light (TL) detection cartridge
Short name	TL
Part number	5022671
Weight	1.5 lbs (0.7 kg)
Read modes	Imaging
Type	Transmitted light
Number of slots	1
Light source	Ultra-high power LED
Wavelength range	White light, brightfield

Luminescence Detection Cartridges

There are three Glow Luminescence (LUM) detection cartridges that support the luminescence read mode. For best results you should use solid white plates. The Glow Luminescence detection cartridges are individually optimized for a 1536-well, 384-well, or 96-well plate format:

- Glow Luminescence (LUM) detection cartridge
- Glow Luminescence (LUM) detection cartridge (384)
- Glow Luminescence (LUM) detection cartridge (96)

Each cartridge occupies one slot in the cartridge drawer.

Dual Color Luminescence (LUM) (Chroma-Glo) Detection Cartridge

The Dual Color Luminescence (LUM) (Chroma-Glo™) Detection Cartridge supports the luminescence read mode and is designed to provide the optimal performance when you use Promega Chroma-Glo™ reagents. This cartridge supports both luminescence and dual wavelength luminescence reads.

This cartridge occupies one slot in the cartridge drawer.

Chroma-Glo is a trademark of Promega Corporation.

Dual Color Luminescence (LUM) (BRET2) Detection Cartridge

The Dual Color Luminescence (LUM) (BRET2™) Detection Cartridge is designed to provide the optimal performance when you use Perkin Elmer BRET² reagents. This cartridge supports both luminescence and dual wavelength luminescence reads. For best results, you should use solid white plates.

This cartridge occupies one slot in the cartridge drawer.

BRET² is a trademark of PerkinElmer, Inc.

These cartridges support the following read types:

- [Endpoint Read Type, see page 114](#)
- [Kinetic Read Type, see page 114](#)
- [Well Scan Read Type, see page 115](#)

Luminescence

Luminescence is the emission of light by processes that derive energy from essentially non-thermal changes, the motion of subatomic particles, or the excitation of an atomic system by radiation. Luminescence detection relies on the production of light from a chemical reaction in a sample.

Each Glow Luminescence (LUM) detection cartridge contains the components to measure the light intensity from luminescence. Since the light is emitted as a result of a chemical reaction, no excitation light and no excitation filters are required to measure luminescence. The luminescence can be measured with no emission filters, or an emission wavelength selected from within the specified range.

You must also install the SpectraMax Injector cartridge to use this detection cartridge to measure flash luminescence reactions. See [SpectraMax Injector Cartridge on page 75](#).

Plate Recommendations

Plate Recommendations for the Luminescence Detection Cartridges

Read Mode	Plate Type	Other Considerations
Luminescence (LUM)	Solid white	When an application specifies a surface treatment, use only plates with the correct treatment. You should use an unlidded plate for luminescence measurements.
Luminescence, Dual Color (LUM-Dual)	Solid white	When an application specifies a surface treatment, use only plates with the correct treatment. You should use an unlidded plate for luminescence measurements.

White plates provide significantly higher signal for luminescence than black plates and are recommended if high sensitivity is required. However, white plates can exhibit some detectable phosphorescence that increases background after being exposed to light (in particular under neon lights). For maximum sensitivity, you should prepare plates under reduced ambient light conditions, and adapt the plates to darkness for 10 to 30 minutes before measurement.

Measurement Specifications

Measurement Specifications for the Luminescence Detection Cartridges

Item	Description	Description	Description
Detection Cartridge Name	Glow Luminescence (LUM) detection cartridge	Glow Luminescence (LUM) detection cartridge (384)	Glow Luminescence (LUM) detection cartridge (96)
Short Name	LUM	LUM 384	LUM 96
Part Number	0200-7012	0200-7015	0200-7014
Weight	1.5 lbs (0.7 kg)	1.5 lbs (0.7 kg)	1.5 lbs (0.7 kg)
Plate Formats	6, 12, 24, 48, 96, 384, and 1536-well plates	6, 12, 24, 48, 96, and 384-well plates	6, 12, 24, 48, 96-well plates
Read Mode	Luminescence (LUM)	Luminescence (LUM)	Luminescence (LUM)
Type	Single emission	Single emission	Single emission
Number of Slots	1 slot	1 slot	1 slot
Light Source	None	None	None
Wavelength Range	Visible to 650 nm	Visible to 650 nm	Visible to 650 nm
Labels/Substrates	Labels compatible with the wavelength range	Labels compatible with the wavelength range	Labels compatible with the wavelength range
Detection Limit (ATP) Optimized	96-well (200 µL) 3 pM 384-well (50 µL) 7 pM 1536-well (8 µL) 20 pM	96-well (200 µL) 2 pM 384-well (50 µL) 3 pM 1536-well (8 µL) NA	96-well (200 µL) 2 pM 384-well (50 µL) NA 1536-well (8 µL) NA
Detection Limit (ATP) Guaranteed	96-well (200 µL) 15 pM 384-well (50 µL) 30 pM 1536-well (8 µL) 60 pM	96-well (200 µL) 10 pM 384-well (50 µL) 15 pM 1536-well (8 µL) NA	96-well (200 µL) 8 pM 384-well (50 µL) NA 1536-well (8 µL) NA
Linear Dynamic Range	5 logs in a single plate read	5 logs in a single plate read	5 logs in a single plate read

Measurement Specifications for the Luminescence Detection Cartridges

Item	Description	Description
Detection Cartridge Name	Dual Color Luminescence (LUM) (BRET2) detection cartridge	Dual Color Luminescence (LUM) (Chroma-Glo) detection cartridge
Short Name	LUM-BRET2	LUM-CHROM
Part Number	0200-7016	0200-7013
Weight	1.5 lbs (0.7 kg)	1.5 lbs (0.7 kg)
Read Mode	Luminescence (LUM) Luminescence, Dual Color (LUM-Dual)	Luminescence (LUM) Luminescence, Dual Color (LUM-Dual)
Type	Dual emission	Dual emission
Number of Slots	1 slot	1 slot
Light Source	None	None
Wavelength Range	EM1: 410-80 EM2: 515-30	EM1: 510-60 EM2: LP610
Labels	Labels compatible with the wavelength range	Labels compatible with the wavelength range

ScanLater Western Blot Detection Cartridge

The ScanLater™ Western Blot (WB) Detection Cartridge supports the Time-Resolved Fluorescence read mode for Western Blot membranes.

The Molecular Devices ScanLater™ Western Blot Assay Kit is a novel system for protein analysis. Membranes are incubated with Eu-chelate labeled secondary antibodies or streptavidin that bind specifically to the target protein-specific primary antibody. For more information, contact your representative or search the knowledge base for ScanLater or Western Blot at support.moleculardevices.com.

The cartridge occupies two slots in the cartridge drawer.

Western Blot reads use the time-resolved fluorescence read mode with a membrane read type. See [Membrane Read Type on page 114](#).

Loading the Membrane Holder



Note: Handle membranes only by the edges using clean forceps. Take care to not touch the membrane with gloved or bare hands.

You must place the membrane in a Molecular Devices ScanLater™ membrane holder to scan a membrane. The maximum size of a membrane that fits in the membrane holder is 109 mm x 77 mm.

To load the membrane holder:

1. Place the membrane on the membrane holder with one corner of the membrane aligned with the A1 corner of the membrane holder.

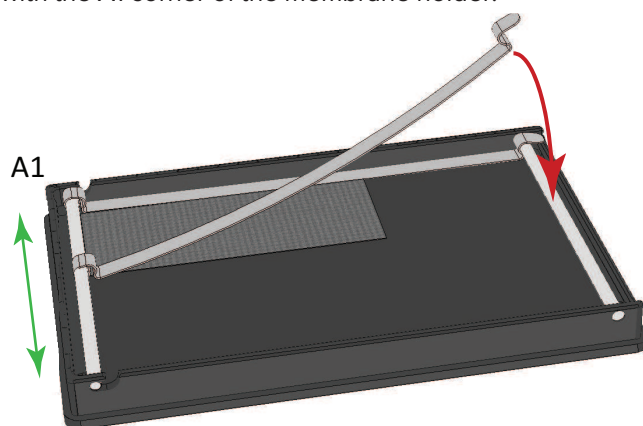

2. Slide the holder clips to place them over the membrane as close to the edges of the membrane as possible to expose the maximum scanning area of the blot.
3. Lower the holder clips into place and then gently press the end of each holder clip to snap it into place and secure the membrane to the holder.



CAUTION! To prevent damage to the instrument or the membrane holder, make sure that all the holder clips are securely snapped into place before you insert the membrane holder into the instrument.

4. Load the membrane holder into the plate drawer with the A1 corner in the A1 position of the drawer. .

Cleaning the Membrane Holder

To remove dust, buffer residue, and smudges that can have a negative effect on image quality or contaminate the membrane, always clean the membrane holder before loading a new membrane for scanning.

The scanning surface can be wiped with methanol, rinsed with a small volume of water, followed by a final rinse with isopropanol to help prevent blot contamination. Pressurized “canned air” can be helpful in removing dust and lint.

Membrane Holder Clips

You can add or remove the holder clips on the membrane holder as needed for your application.

1. If the clips are in the locked position, then unfasten the clips by pulling up on the tabs.
2. Slide the retainer bar on the "A" column side of the membrane holder out from its slots.

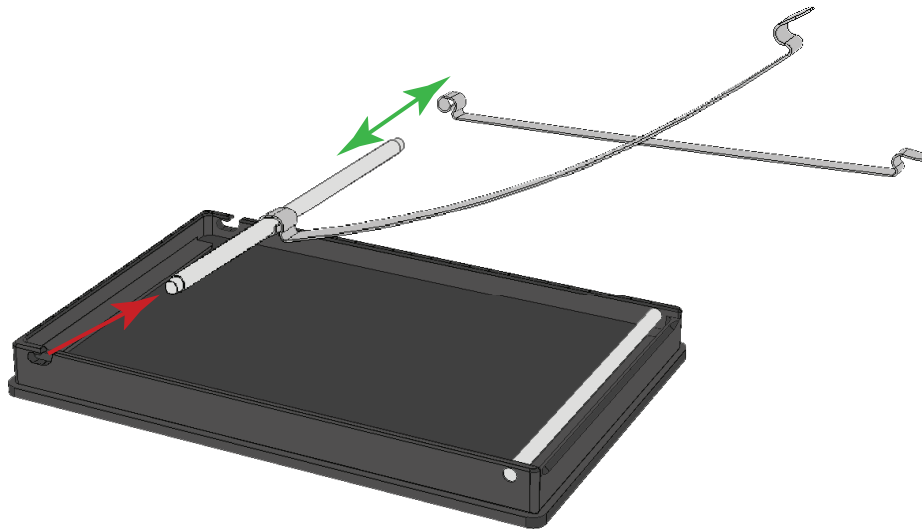

3. Slide the holder clip on or off the end of the retainer bar.



Note: When you add a holder clip, make sure that the tab is on top and that the center of the holder clip curves downward toward the plate.

4. Slide the retainer bar into the two slots and press the bar until it snaps into place.

Measurement Specifications

Measurement Specifications for the ScanLater Western Blot (WB) Detection Cartridge

Item	Description
Detection Cartridge Name	ScanLater Western Blot (WB) Detection Cartridge
Short Name	SCANLATER WB
Part Number	0200-7027
Weight	2.6 lbs (1.2 kg)
Read Modes	Time-Resolved Fluorescence (TRF)
Type	Single emission
Number of Slots	2 slots
Light Source	Ultra-high power LED
Filter Set	EX: 340-80 EM: 616-10
Labels	Europium chelate
Detection Limit	50 amol
Linear Dynamic Range	5 logs in a single membrane scan

Time Resolved Fluorescence Detection Cartridges

Time Resolved Fluorescence (TRF-EUSA) Detection Cartridge

The Time Resolved Fluorescence (TRF-EUSA) detection cartridge supports the time-resolved fluorescence read mode for Europium and Samarium. It is ideal for protein interaction, GPCR, and enzyme activity applications. For best results you should use solid black plates.

This cartridge occupies one slot in the cartridge drawer.

These cartridge support the following read types:

- [Endpoint Read Type](#), see page 114
- [Kinetic Read Type](#), see page 114
- [Well Scan Read Type](#), see page 115 (Not available for dual-label assays.)

Time-Resolved Fluorescence

Time-Resolved Fluorescence is a measurement technique that depends on three characteristics that lead to better discrimination between the specific signal, proportional to the quantity of label, and the unspecific fluorescence resulting from background and compound interference:

- Pulsed excitation light sources
- Time-gated electronics faster than the fluorescence lifetime
- Labels with prolonged fluorescence lifetime

The time-gating electronics introduce a delay between the cutoff of each light pulse and the start of signal collection. During the delay, the unspecific fluorescence (caused by test compounds, assay reagents, and the plate) vanishes, while only a small portion of the specific fluorescence from the label is sacrificed. Enough of the specific signal remains during the decay period, with the added benefit of reduced background.

The Time Resolved Fluorescence (TRF-EUSA) detection cartridge uses an ultraviolet LED that emits in the range between 350 nm and 380 nm for excitation of Europium chelates and comes equipped with emission filters for europium and samarium. This allows single-label europium and samarium assays and dual-label assays that involve europium and samarium to be run.



Note: Europium cryptate and terbium require excitation wavelengths below 330 nm and cannot be measured with this detection cartridge.

Plate Recommendations

Plate Recommendations: Time Resolved Fluorescence (TRF-EUSA) Detection Cartridge

Read Mode	Plate Type	Other Considerations
Time-Resolved Fluorescence (TRF)	Solid white	When an application specifies a surface treatment, use only plates with the correct treatment.

Measurement Specifications

Measurement Specifications for the Time Resolved Fluorescence Detection Cartridges

Item	Description	Description
Detection Cartridge Name	Cisbio HTRF detection cartridge	Time Resolved Fluorescence (TRF-EUSA) Detection Cartridge
Short Name	HTRF	TRF-EUSA
Part Number	0200-7011	0200-7008
Weight	2.6 lbs (1.2 kg)	1.5 lbs (0.7 kg)
Read Modes	Time-Resolved Fluorescence Resonance Energy Transfer (TR-FRET)	Time-Resolved Fluorescence (TRF) Time-Resolved Fluorescence, Dual-Label (TRF-Dual)
Type	Dual emission	Dual emission
Number of Slots	2 slots	1 slot
Light Source	Xenon flash lamp	Ultra-high power LED
Filter Set	EX: HTRF EM1: 616-10 EM2: 665-10	EX: 370-80 EM1: 616-10 EM2: 642-10
Labels	Europium cryptate, Europium acceptors	Europium chelate, Samarium chelate
Detection Limit Optimized		384-well (100 μ L): 3 amol/0.03 pM 1536-well (8 μ L): 1 amol/0.125 pM
Detection Limit Guaranteed		384-well (100 μ L): 10 amol/0.1 pM 1536-well (8 μ L): 3 amol/0.375 pM
Linear Dynamic Range		6 logs in a single plate read

Cisbio HTRF Detection Cartridge

The Cisbio HTRF® Detection Cartridge uses a high-energy Xenon flash lamp for sensitive reads of HTRF reagents. The standard dual-emission design gives the most accurate results in short overall read time. This cartridge provides Time-Resolved Fluorescence read mode for europium cryptate and europium acceptors.

The fluorescence ratio related to the HTRF readout is a correction method developed by Cisbio, for which Cisbio has granted a license to Molecular Devices. Its application is strictly limited to the use of HTRF reagents and technology, excluding other TR-FRET technologies such as IMAP TR-FRET calculations of acceptor to donor ratios.

This is a dual-emission cartridge that occupies two slots in the cartridge drawer.

The cartridge supports the following read types:

- [Endpoint Read Type, see page 114](#)
- [Kinetic Read Type, see page 114](#)
- [Well Scan Read Type, see page 115](#)

HTRF is a registered trademark of Cisbio Bioassays.

Homogeneous Time-Resolved Fluorescence

Homogeneous Time-Resolved Fluorescence (HTRF) is a measurement technique based on fluorescence resonance energy transfer (FRET) that uses the advantages of Time-Resolved Fluorescence (TRF) read.

The Cisbio HTRF detection cartridge uses a Xenon flash lamp. The excitation filter selects wavelengths suitable for the excitation of Europium cryptates below 330 nm. Emission filters detect signal for Europium cryptate (616 nm) and typical Europium acceptor labels (665 nm).

The Cisbio HTRF detection cartridge provides the optimal performance for key applications for drug discovery, bioprocess development, and others.

- GPCR Assays
- Cytokine Assays
- cAMP Quantitation
- Human mAb Screening
- Kinase Assays

Plate Recommendations

Plate Recommendations for the Cisbio HTRF detection cartridge

Read Mode	Plate Type	Other Considerations
Time-Resolved Fluorescence Resonance Energy Transfer (TR-FRET)	Solid white	When an application specifies a surface treatment, use only plates with the correct treatment.

Measurement Specifications

Measurement Specifications for the Cisbio HTRF detection cartridge

Item	Description
Detection cartridge name	Cisbio HTRF detection cartridge
Short name	HTRF
Part number	0200-7011
Weight	2.6 lbs (1.2 kg)
Read mode	Time-Resolved Fluorescence Resonance Energy Transfer (TR-FRET)
Type	Dual emission
Number of slots	2 slots
Light source	Xenon Flash Lamp
Filter set	EX: HTRF EM1: 616-10 EM2: 665-10
Labels	Europium cryptate, Europium acceptors
Applications	HTRF certified by Cisbio Bioassays

The SpectraMax® Injector Cartridge adds injector capability to the SpectraMax i3x. You can use the injectors and optics in this cartridge for luminescence reads from the top of the sample or use the injectors in the cartridge along with the instrument's built-in monochromator for fluorescence intensity reads from the bottom of the sample.

Install the SpectraMax Injector cartridge in the two rear-most slots (3 and 4) in the cartridge drawer.

When you install the SpectraMax Injector cartridge, you can create protocols that inject and read well by well to reduce signal loss. Injectors deliver a specified volume of a reagent to the wells of a plate. Use the injectors to deliver the reagent to initiate a reaction that occurs rapidly and results in a luminescent or fluorescent signal that the instrument must quickly detect.

Common inject-and-read assays include luciferase reporter assays and calcium flux assays.

The SpectraMax Injector cartridge is DLReady™ certified by Promega for the Dual-Luciferase Reporter (DLR™) assay system.



DLReady, DLR, and the DLReady logo are trademarks of Promega Corporation.

To define the settings for a read with injection, you must use the Acquisition View in the Settings dialog.

Installing the Injector Cartridge

The SoftMax Pro Software detects the installed SpectraMax Injector cartridge and displays settings on the Settings dialog to enable the read modes you can use with the SpectraMax Injector cartridge.

The SpectraMax Injector cartridge is installed in the two rear-most slots (3 and 4) in the detection cartridge drawer. Do not install any other cartridges in slot 4.



Note: When you use the software in offline mode, all detection cartridges are available on the Settings dialog, including the SpectraMax Injector cartridge. You can define non-injector luminescence reads that use the SpectraMax Injector cartridge in the Standard View or Acquisition View on the Settings dialog. However, to define reads with injectors, you must use the Acquisition View. See the *SoftMax Pro Data Acquisition and Analysis Software User Guide* or the application help.

To install the SpectraMax Injector cartridge:

 **CAUTION!** To prevent damage to the installed detection cartridges and the instrument, do not manually slide the detection cartridge drawer in or out when the instrument is powered on or when one or more detection cartridges are installed in the drawer.

1. Remove the bottles from the bottle holder.



2. On the microplate reader touchscreen, touch  to open the detection cartridge drawer and to display the Injector screen. The Injector cartridge installs in slots three and four in the back of the detection cartridge drawer.

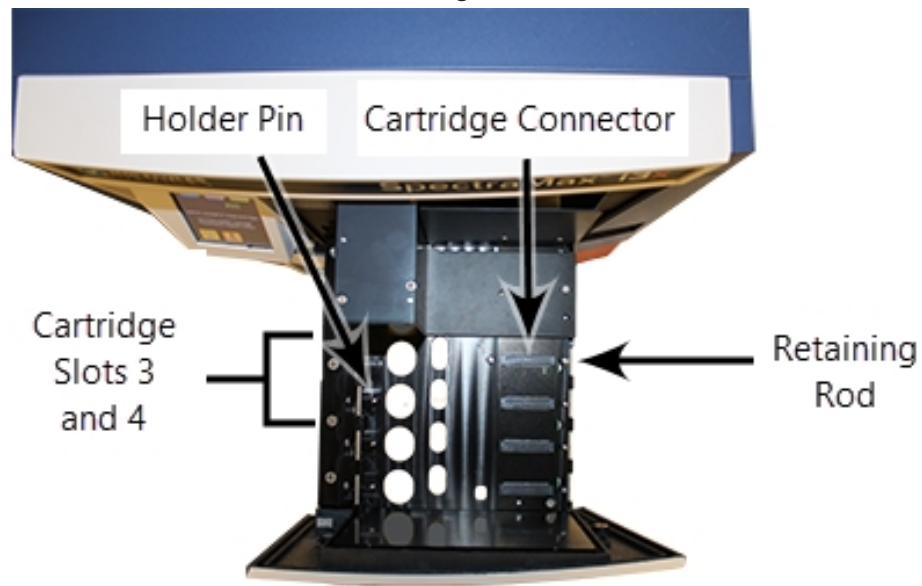

Detection Cartridge Drawer Slots 3 and 4 for the Injector Cartridge

3. With the bottle holder facing the rear of the instrument, position the small hole and the connector pins on the bottom of the Injector Cartridge over the holder pin and connector of cartridge slots 3 and 4.

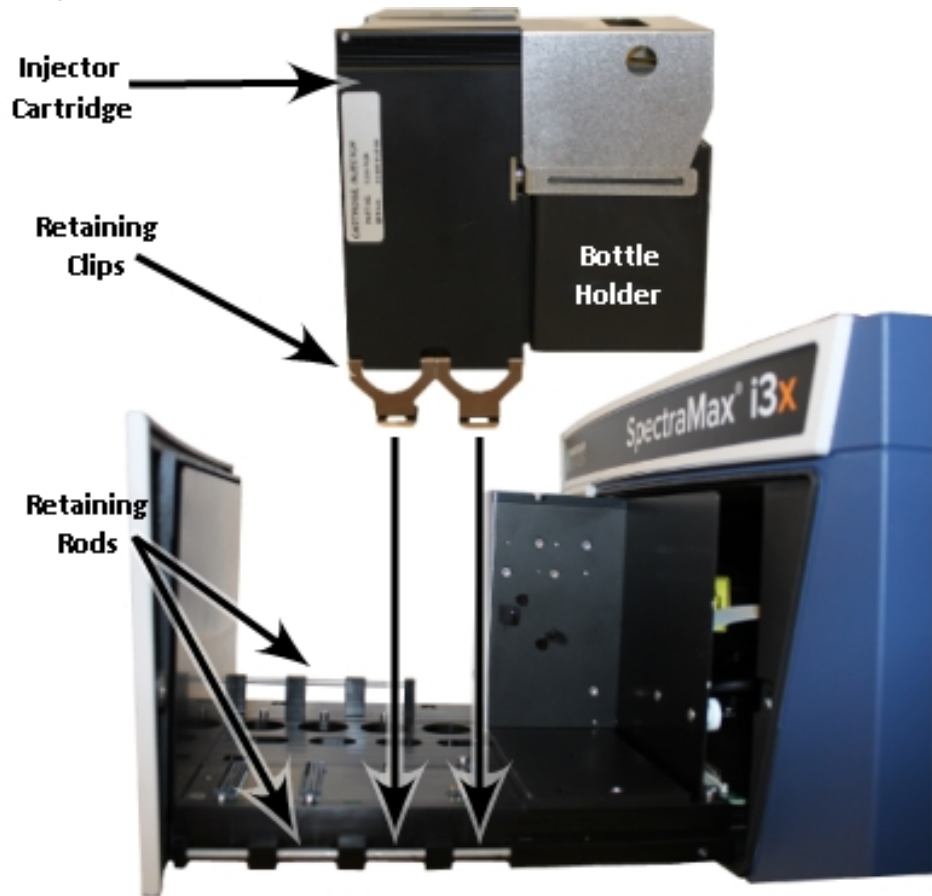

4. Gently but firmly push the cartridge onto the holder pin and connector so that the cartridge is fully seated in cartridge slots 3 and 4.
5. Push the two retaining clips on the right side of the cartridge so that they fasten securely to the retaining rod.
6. Push the retaining clip on the left side of the cartridge so that it fastens securely to the retaining rod.
7. When a message displays on the touchscreen, insert the waste plate and the strip wells. See [Injector Waste Plate and Strip Wells on page 82](#).
If you are ready for an experiment, fill the bottles and prime the injectors before you close the detection cartridge drawer. See the following topics:

- [Injector Bottles on page 83](#)
- [Priming Injector Tubing on page 85](#)

8. Close the top cover over the bottle holder so that there is enough clearance between the top of the cartridge and the top of the drawer opening before you close the drawer.



9. Touch  to close the detection cartridge drawer.

10. Remove the waste plate from the plate drawer.
You should leave the strip wells in the plate drawer whenever the SpectraMax Injector cartridge is installed.



11. Touch  to close the plate drawer.
12. Start the SoftMax Pro Software and connect to the instrument.
If the software is running and connected to the instrument, select the Operations tab and click **Refresh** to have the software detect the cartridges.



CAUTION! To prevent dust from collecting inside the instrument, the detection cartridge drawer should be open only for as long as necessary to install or remove detection cartridges. Keep the detection cartridge drawer closed whenever possible.

SpectraMax Injector Cartridge Parts and Accessories

The SpectraMax Injector cartridge and accessories are available to order from Molecular Devices.

Part Number	Description
0200-7029	SpectraMax Injector cartridge
5044162	Injector Bottle Holder
5044163	Injector Waste Plate
5044164	Injector Tubing
5044165	Injector Adapter
Not orderable from Molecular Devices	Wide-neck bottle, HDPE 50 mL capacity 36 mm square by 68 mm high 24 mm diameter inside neck Recommended supplier: VWR (215-0440)
Not orderable from Molecular Devices	Strip wells, polystyrene 1x8, clear, flat-bottomed Recommended supplier: Greiner Bio-One (762001)

Compatible Solutions

Use only compatible solutions with the SpectraMax Injector cartridge.

The following table gives a partial list of commonly used compatible and incompatible solutions for dispensing through the injector tubing or for exterior cleaning of the SpectraMax Injector cartridge and accessories. Most reagents are compatible with the SpectraMax Injector cartridge, as long as the components used in the solution are in the compatible list. For a complete substance compatibility list, visit the knowledge base on the Molecular Devices technical support site.

Before you use a substance that is not listed, contact Molecular Devices technical support. See [Obtaining Support on page 164](#).



CAUTION! The information in this table is based on substance-compatibility information provided by suppliers of the materials used in the SpectraMax Injector cartridge and other reputable sources. Before you run an assay, always test the behavior of substances under the specific conditions of your application.

Compatible and Incompatible Solutions

Compatible Substances	Do Not Use
Alcohol, Ethyl (Ethanol), 70% solution or less	Acetone
Alcohol, Isobutyl (Isobutanol), 70% solution or less	Alcohol, Benzyl (Phenylcarbinol)
Alcohol, Methyl (Methanol), 70% solution or less	Hydrochloric Acid (HCl)
Ammonia, 10% solution or less	Ketones
Sodium Hypochlorite (NaClO), 3% solution or less	Sulfuric Acid (H ₂ SO ₄)
Water (deionized, distilled, or fresh)	Water (salt or saline)



CAUTION! Always read the label or Safety Data Sheet (SDS) to determine the actual percentage of the substance in a solution. Example: Household bleach generally contains approximately 5% sodium hypochlorite, so a 50% reduction yields less than a 3% solution of NaClO.

Plate Recommendations

The following plate recommendations are specific to the SpectraMax Injector cartridge. For reads with injection, plates must be unlidded.

Plate Guidelines for the SpectraMax Injector Cartridge

Read Mode	Plate Type	Other Considerations
Luminescence (LUM), top read	Solid white If luminescence crosstalk is high, then use a black plate to improve sensitivity.	When an application specifies a surface treatment, use only plates with the correct treatment. You should use an unlidded plate for luminescence measurements. For reads with injection, plates must be unlidded.
Fluorescence Intensity (FL), bottom read	Black-sided, clear bottomed	When an application specifies a surface treatment, use only plates with the correct treatment.



Note: White plates provide significantly higher signal for luminescence than black plates and are recommended if high sensitivity is required. However, white plates can exhibit some detectable phosphorescence that increases background after being exposed to light (in particular under neon lights). For maximum sensitivity, you should prepare plates under reduced ambient light conditions, and place the plate inside the instrument for 1 to 10 minutes to adapt the plates to darkness before you start the read.

Measurement Specifications

Measurement Specifications for the SpectraMax Injector Cartridge

Item	Description
Cartridge Name	SpectraMax Injector Cartridge
Short Name	INJECTOR
Part Number	0200-7029
Weight	1.7 kg (3.7 lbs)
Plate Formats	6, 12, 24, 48, 96, and 384-well plates
Read Modes	Luminescence (LUM) reads from the top You can also use the injectors in the cartridge along with the built-in monochromator in the SpectraMax i3x for Fluorescence Intensity (FL) reads from the bottom of the sample.
Type	Single emission
Number of Slots	2 slots, including the rear-most slot number 3 that is dedicated for the SpectraMax Injector cartridge
Light Source	None

Measurement Specifications for the SpectraMax Injector Cartridge (continued)

Item	Description
Wavelength Range (LUM)	Visible to 650 nm
Labels/Substrates	Labels compatible with the wavelength range
Detection Limit, Optimized	20 amol ATP ("Flash" luminescence using Promega Enliten)
Detection Limit, Guaranteed	50 amol ATP (\leq 250 fM @ 0.2mL/well, "Flash" luminescence using Promega ENLITEN ATP Assay System) 3 fmol ATP (\leq 15 pM @ 0.2mL/well, "Glow" luminescence using PerkinElmer ATPlite 1step)
Linear Dynamic Range	5 logs in a single plate read
Injectors	2
Dispense Volume	1 μ L increments from 1 μ L to the maximum allowable volume of the well, based on the selected plate type
Dispense Accuracy	$\pm(4\%$ of volume + 1 μ L) / volume x 100%
Dispense Precision	$\leq 2\%$ of volume + 1 μ L) / volume [μ L] x 100% cv
Dispense Speed	100 μ L per second
Dead Volume	50 mL bottle: 1 mL Injector tubing: 250 μ L Fill the bottles with enough reagent for your experiment plus at least 2 mL to account for the prime operation and the quick-prime operation before the plate is read, and for the dead volume in the bottle and the tubing.
Minimum Delay Between Injection and LUM (top) Read	Injector 1: 0.3 seconds after injection ends Injector 2: 0.3 seconds after injection ends
Minimum Delay Between Injection and FL (bottom) Read	Injector 1: 0.0 seconds when injection starts Injector 2: 0.3 seconds after injection ends

Using the SpectraMax Injector Cartridge

Before you use the SpectraMax Injector cartridge or do maintenance operations, make sure that you are familiar with the safety information in this guide. See [Safety Information on page 5](#).

For information on how to control the SpectraMax Injector cartridge with the software, see the *SoftMax Pro Data Acquisition and Analysis Software User Guide* or the application help.



WARNING! BIOHAZARD. Depending on your usage, the SpectraMax Injector cartridge can have biohazardous material in and on it. When handling the cartridge, always use the personal protective equipment (PPE) prescribed by your laboratory.

Injector Waste Plate and Strip Wells

The waste plate provided with the SpectraMax Injector cartridge captures excess liquid during prime, rinse, and wash operations. The instrument uses the provided strip wells during the quick-prime of the injectors when you start a read with injectors.



Note: Make sure that the waste plate and strip wells are empty before you install them.

During the installation of the SpectraMax Injector cartridge, the plate drawer opens and messages on the touchscreen prompt you to insert the waste plate and the strip wells. If the

SpectraMax Injector cartridge is already installed, then touch  to open the plate drawer.

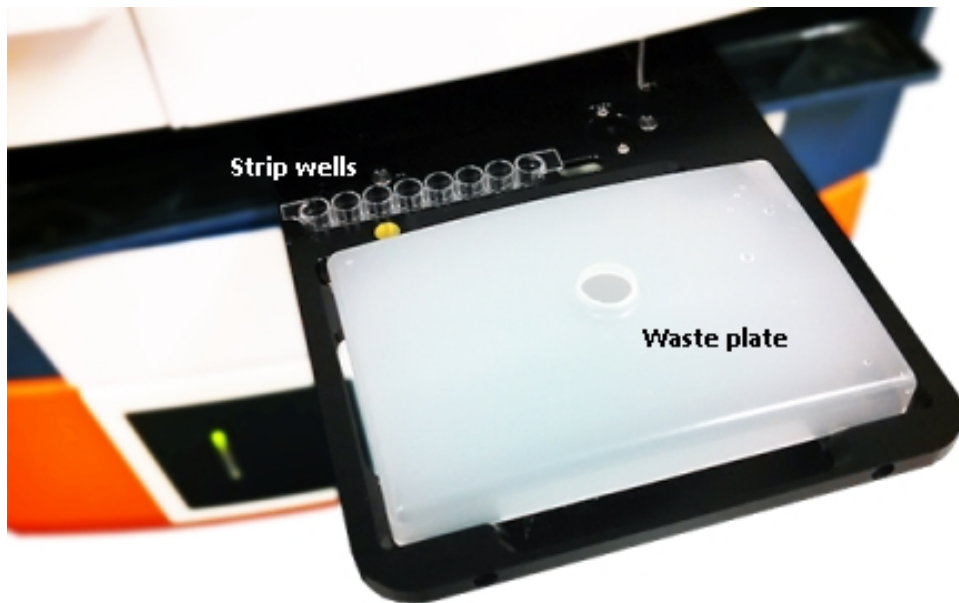

- Install the empty waste plate in the same location as a plate.
- Install the empty strip wells in the smaller slot next to the plate.

When you run an experiment, replace the waste plate with your prepared plate. The empty strip wells must remain in the plate drawer, since they are used during the 10 μ L quick-prime of the injectors when you start a read with injectors.

You should leave the strip wells in the plate drawer whenever the SpectraMax Injector cartridge is installed in the instrument. Remove the waste plate before you close the plate drawer.

Injector Bottles

The bottle holder on the SpectraMax Injector cartridge holds two bottles that correspond with the two injectors. Fill the bottles with enough reagent for your experiment plus at least 2 mL to account for the prime operation and the quick-prime operation before the plate is read, and for the dead volume in the bottle and the tubing. Place the bottles in the positions that correspond with the injectors you define in your protocol.

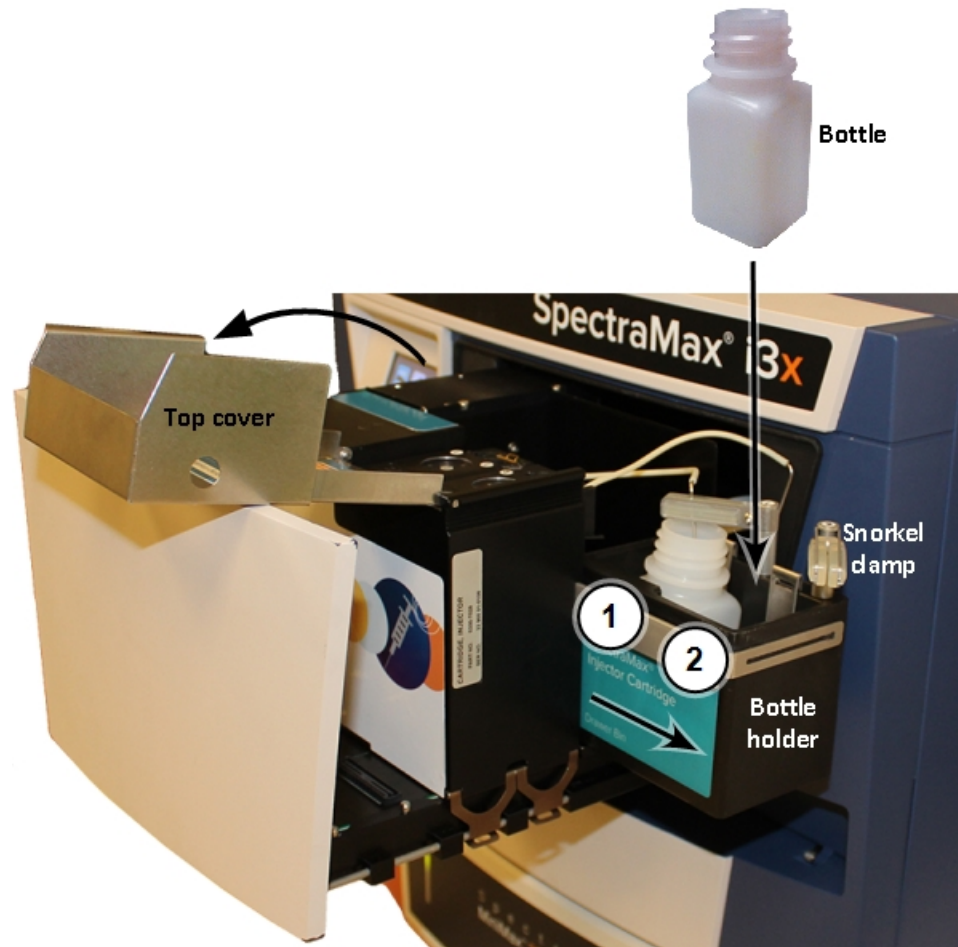

You can insert bottles with the SpectraMax Injector cartridge on a workbench or after the you install the cartridge in the instrument. This procedure describes how to insert the bottles after you install the cartridge.

1. With the detection cartridge drawer open, lift the top cover of the SpectraMax Injector cartridge and swing the cover to its fully open position.
2. Slide the bottle holder away from the cartridge body.

- Slide the snorkel tube out of the open side of the snorkel clamp, and then slide it upward out of the bottle.

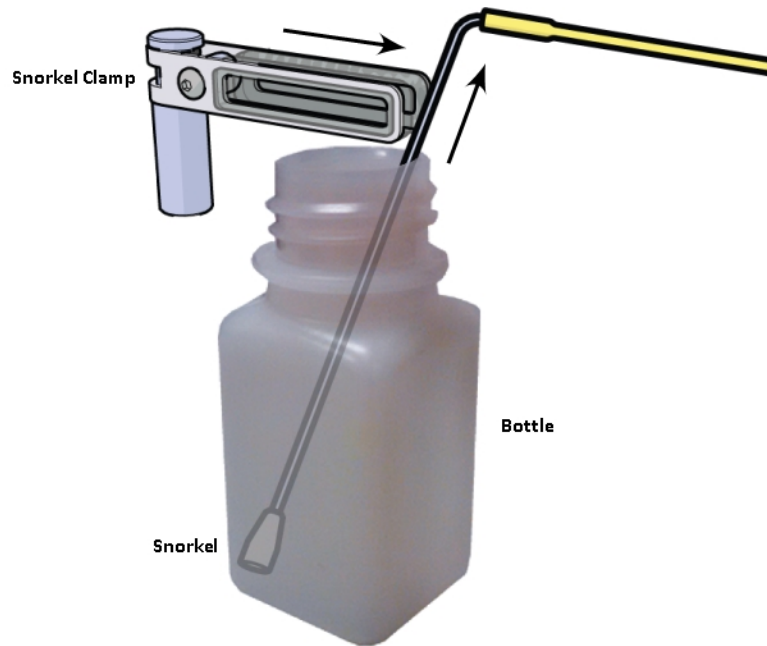

- Twist the snorkel clamp to clear the position where the bottle is to be placed.
- Remove the old bottle, if present, and then slide the new bottle into its position until the bottom of the bottle rests on the bottom of the bottle holder.
- Twist the snorkel clamp back into position over the bottle.
- Slide the snorkel all the way down into the bottle, and then slide the snorkel tube into the open end of the snorkel clamp.

The bottle holder is slightly tilted toward one corner. To extract the maximum amount of liquid from the bottle, place the end of the snorkel in the lowest point that is located in the corner of the bottle closest to the closed end of the snorkel clamp.

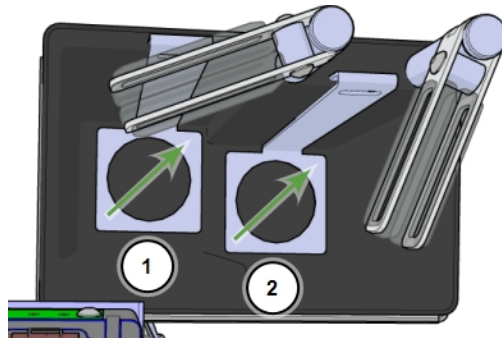

Lowest Points of the Bottle Holder

- Insert a second bottle into the other position of the bottle holder and insert its snorkel.
- Slide the bottle holder back into place on the cartridge body.
- Swing the top cover to its fully closed position.
- Fully close the top cover over the bottle holder so that there is enough clearance between the top of the cartridge and the top of the drawer opening before you close the drawer.

Bottle Holder Adapters

Adapters are supplied with the SpectraMax Injector cartridge. Insert the adapter in the bottle holder to accommodate smaller labware. Each adapter has several hole positions, one for 1 mL tubes and others for larger vessels.

Insert the adapters in the bottle holder before you insert the alternate labware. After you install the labware, insert the snorkels into the labware and secure the snorkels in their snorkel clamps.

Priming Injector Tubing

Prime the injector tubing with the reagent for your experiment before you run a read with injectors.

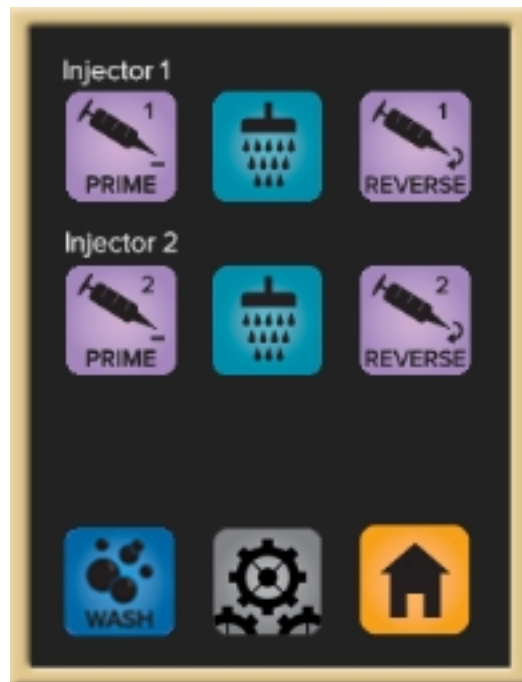



The Injector screen displays options to prime each injector tubing separately.

To prime the injector tubing:



1. Touch **INJECT** on the Home screen to display the Injector screen.
2. Insert the empty waste plate and the empty strip wells on the plate drawer.
3. Fill the bottles with enough reagent for your experiment plus at least 2 mL to account for the prime operation and the quick-prime operation before the plate is read, and for the dead volume in the bottle and the tubing. Place the bottles in the positions that correspond with the injectors you define in the protocol.

4. Touch  for the injector tubing with a filled bottle.

If you use both bottles in your experiment, touch  after the first prime operation completes.

Each tubing holds 250 μL . The prime operation dispenses 260 μL through the tubing, leaving 10 μL in the waste plate.

During a prime, rinse, or wash operation, and during a plate read, the nozzle that contains the injector tips and the optics lowers to 0.5 mm above the opening of the waste plate or the top of the plate to inject the reagent and to detect the luminescence signal.

5. After the prime operation completes, touch .
6. Fully close the top cover over the SpectraMax Injector cartridge bottle holder.

7. In the Home screen, touch  to close the detection cartridge drawer.
8. Remove the waste plate from the plate drawer and replace it with your prepared plate.

9. Touch  to close the plate drawer.
10. Use the SoftMax Pro Software to run your experiment. See the *SoftMax Pro Data Acquisition and Analysis Software User Guide* or the application help.

Clearing Injector Tubing

After you finish using the injectors, clear the reagent from the injector tubing. The system uses a “reverse prime” to aspirate the reagent in the tubing and return it to the bottle. This can save valuable reagents from going to waste. The reverse prime operation recovers nearly all of the 250 μ L of reagent in the tubing, leaving behind less than 10 μ L. To maximize reagent recovery, run the reverse prime a second time.

You should also clear the injector tubing before you remove the SpectraMax Injector cartridge from the instrument.

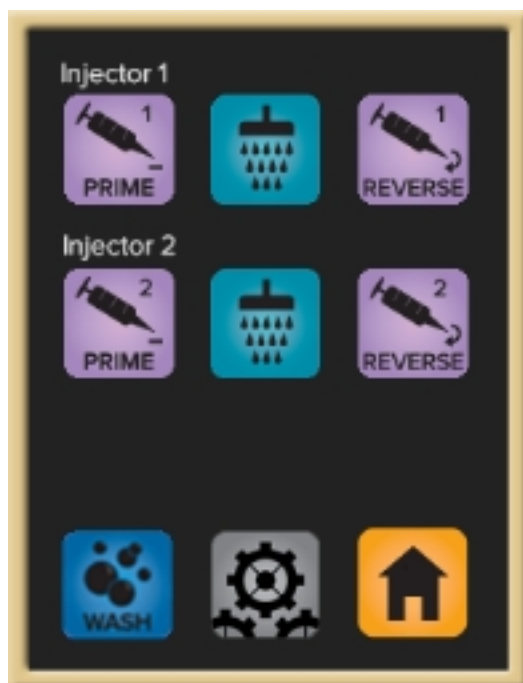

The Injector screen enables you to clear each injector tubing separately.

1. Remove the plate from the plate drawer.



2. Touch  on the Home screen to display the Injector screen.
3. Insert the empty waste plate on the plate drawer.



4. Touch  for the injector that has reagent in its tubing.



If both injectors contain reagent, touch  after the first clear operation completes.

After the injector tubes are clear, remove the bottles from the cartridge, or remove the cartridge from the instrument.



Note: To ensure optimal operation of the SpectraMax Injector cartridge, you should rinse the injector tubing after every use, and periodically wash the tubing.

Rinsing Injector Tubing

To ensure optimal operation of the SpectraMax Injector cartridge, you should rinse the injector tubing after every use. You should also rinse the injector tubing before you switch between the different reagents you use for the experiments. You should rinse the injector tubing with deionized water. For a list of compatible solutions, see [Compatible Solutions on page 79](#).

The Rinse operation lets you manually control the amount of liquid to dispense through the injector tubing for rinsing or washing. To use the automated Wash operation, see [Washing Injector Tubing on page 89](#).

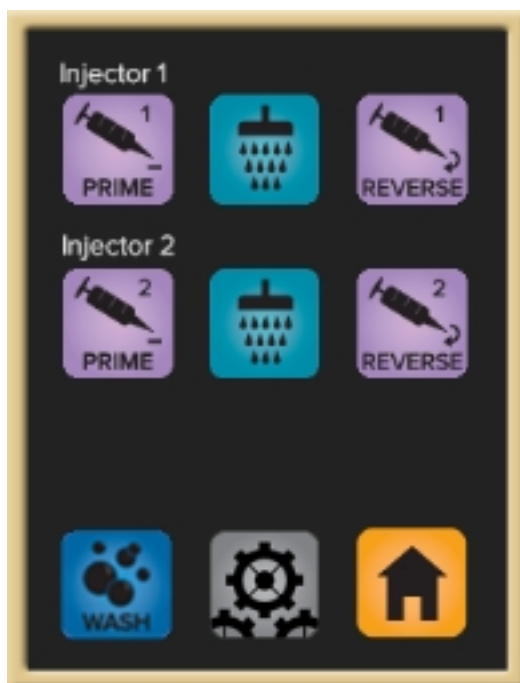

The Injector screen enables you to rinse each injector tubing separately.



1. Touch  on the Home screen to display the Injector screen.
2. If reagent is still in the tubing, run a reverse prime operation.
3. Insert an empty waste plate and empty strip wells on the plate drawer.
4. Fill a bottle with at least 1000 μL of rinse liquid, and then place the filled bottle in the bottle holder.



Tip: To rinse both injector tubings, you can fill two bottles with rinse liquid, or fill just one bottle and put both snorkels in the same bottle.





5. Touch and hold  for the injector with the filled bottle.

The touchscreen displays the volume of liquid that dispenses while you hold the button, in 50 μL increments. You should rinse with a minimum of 400 μL .

During a prime, rinse, or wash operation, and during a plate read, the nozzle that contains the injector tips and the optics lowers to 0.5 mm above the opening of the waste plate or the top of the plate to inject the reagent and to detect the luminescence signal.

6. Release  to stop dispensing liquid.

To rinse both injector tubings, touch and hold the other  button after the first rinse operation completes.

7. After the injector tubing is rinsed, touch  .
If you put both snorkels into a single bottle, return the snorkels to their assigned snorkel clamps.
8. Fully close the top cover of the SpectraMax Injector cartridge bottle holder.

9. In the Home screen, touch  to close the detection cartridge drawer.
10. Remove the waste plate from the plate drawer and empty the contents to waste as prescribed by your laboratory procedures.

11. Touch  to close the plate drawer.

Washing Injector Tubing

To ensure optimal operation of the SpectraMax Injector cartridge, periodically wash the injector tubing. You should wash the injector tubing with deionized or distilled water for rinse cycles and 70% alcohol for a disinfectant cycle.

The automated Wash operation can dispense defined volumes of up to three solutions with defined wait times between the dispenses. To manually control the amount of liquid dispensed through the injector tubing for rinsing or washing, see [Rinsing Injector Tubing on page 88](#).

During a prime, rinse, or wash operation, and during a plate read, the nozzle that contains the injector tips and the optics lowers to 0.5 mm above the opening of the waste plate or the top of the plate to inject the reagent and to detect the luminescence signal.

Touch  to display the Wash Settings screen where you can customize the steps of the Wash operation. See [Custom Wash Settings on page 93](#).

*** Tip:** Instead of switching the bottles in and out of the bottle holder between the solutions, you can insert two different solutions in the bottle holder and then switch the snorkels between the bottles for each step of the Wash operation.

The Wash screen enables you to wash each injector tubing separately or to wash them both at the same time.



To run the default wash cycle:



1. Touch  on the Injector screen to display the Wash screen.



2. If reagent is still in the tubing, touch  to run a reverse prime operation.
3. Insert an empty waste plate and empty strip wells on the plate drawer.
4. Fill a bottle with enough solution for each injector tubing to wash with that solution, and then place the filled bottle in the bottle holder.
5. Fill another bottle with enough solution for each injector tubing to wash with that solution, and then place the filled bottle in the bottle holder.

If you use a third solution for the Wash operation, then fill a third bottle with enough solution for each injector tubing to wash with that solution, and then place the bottle to the side until the third wash step.

6. Place the snorkel for the injector tubing to wash into the bottle that contain solution 1. If you are washing both injector tubings, then place both snorkels in the bottle that contains solution 1.

7. Touch  for the injector tubing to wash.

To wash both injector tubings, touch  for both injector tubings.

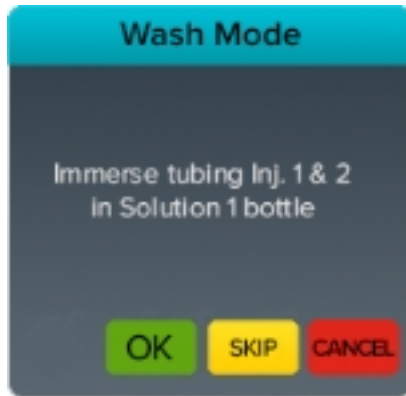

8. Touch **OK** to start the wash step.
9. After the first wash step completes and a message appears, move the snorkel or snorkels to the bottle that contains solution 2.

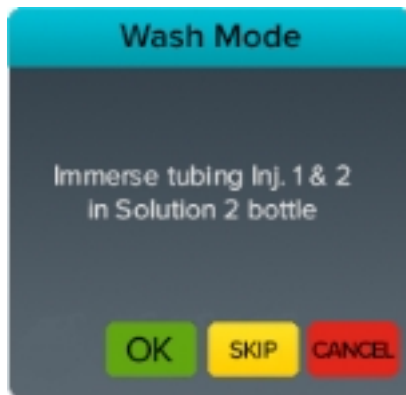

10. Touch **OK** to start the second wash step.

11. A message appears after the second wash. Move the snorkel or snorkels to the bottle that contains solution 3.

If you use a third solution, remove the bottle that contains solution 1 and replace it with the bottle that contains solution 3 before you move the snorkels.

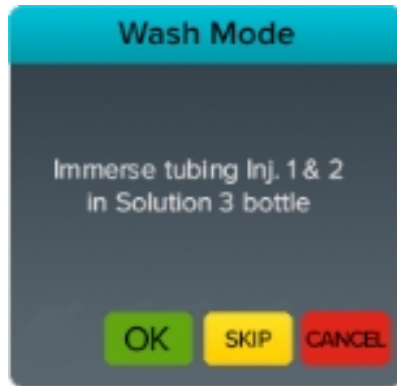

12. Touch **OK** to start the third wash step.
13. A message appears after the third wash. Remove the snorkel or snorkels from the bottles.



14. Touch **OK** to aspirate air that dries the inside of the tubing.
15. After the aspirate air step completes, touch **OK** to display the Wash screen.
16. Remove the bottles from the bottle holder.
17. Empty the bottles and optionally return them to the bottle holder.
18. Return the snorkels to their assigned snorkel clamps.



19. Touch  to return to the Injector screen.



20. Touch  to return to the Home screen.



21. Touch  to close the detection cartridge drawer.
22. Remove the waste plate from the plate drawer and empty the contents to waste as prescribed by your laboratory procedures.



23. Touch  to close the plate drawer.

Custom Wash Settings

The Custom Wash Settings screen enables you to set the volume and rest time between steps for each of the four steps of a standard Wash operation:





- First step: Wash with Solution 1
Example, you can run the first wash step with deionized water.
- Second step: Wash with Solution 2
Example, you can run the second wash step with 70% ethanol.
- Third step: Wash with Solution 3
For the third step, you can repeat a water wash or use a third solution.
- Fourth step: Aspirate air to dry the inside of the tubing



To view the Custom Wash Settings screen, touch  on the Wash screen.



Custom Wash Settings

Button	Description
	Touch to decrease the volume or rest time. The minimum volume is 0 µL. The minimum rest time is 0 seconds. Set the volume to zero to skip this wash step.
	Touch to increase the volume or rest time. The maximum volume is 50000 µL. The maximum rest time is 360 seconds.
	Touch to go to the previous screen.
	Touch to go to the next screen.
	Touch to return to the Wash screen.

Calibrating Dispense Volume

The accuracy of the dispense volume is calibrated in the factory. You should periodically verify the dispense accuracy by running the gravimetric tubing calibration procedure. If the dispense accuracy changes, due to environmental conditions or the viscosity of the assay solution, use the volume adjustment setting to calibrate the dispense volume. When you replace worn out tubing, you should perform a before and after calibration to ensure consistent results.

When not in use for long periods of time, open the stabilizer lids on top of the pumps from the cartridge, remove the tubing to relieve compression on the tubing. This helps to retain uniformity of the tubing and ensure repeatability. Before use, install tubing and make sure you have closed the stabilizer lids.

1. Insert the empty waste plate and the empty strip wells on the plate drawer.



2. From the Wash screen, touch  to display the Tubing Volume screen..



3. Touch  to display the Adjust Volume screen.



4. Touch  for the injector to adjust.



5. Fill a bottle with at least 30 mL of the liquid you to use for the adjustment, and then insert the bottle in the bottle holder.
6. Insert the snorkel for the injector you are adjusting into the bottle.



7. Touch  to prime the tubing.
8. Wait until the prime operation completes and the detection cartridge drawer closes.

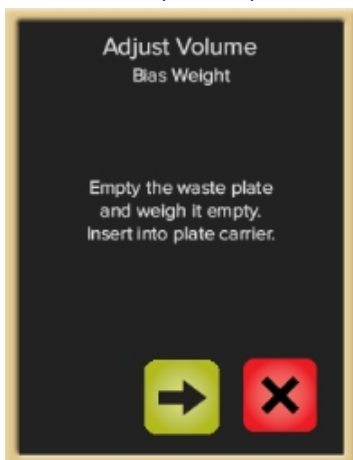

9. Remove and empty the waste plate.
10. Use a lab scale to weigh the empty waste plate.
The empty weight is to be subtracted from the post-dispense weight to determine the volume of liquid that was dispensed.
11. Insert the waste plate on the plate drawer.



12. Touch  to dispense the liquid into the waste plate.

13. Wait until the dispense operation completes and the detection cartridge drawer closes.



14. Remove the waste plate and weigh it.
15. Subtract the post-dispense weight from the empty weight.
16. If the calculated weight does not match the weight that displays on the touchscreen, touch

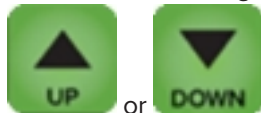

or until the display weight matches the calculated weight.

17. If the density of the liquid you use does not match the display density on the touchscreen,

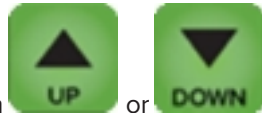

touch or until the display density matches the density of the liquid you use.



18. Touch .

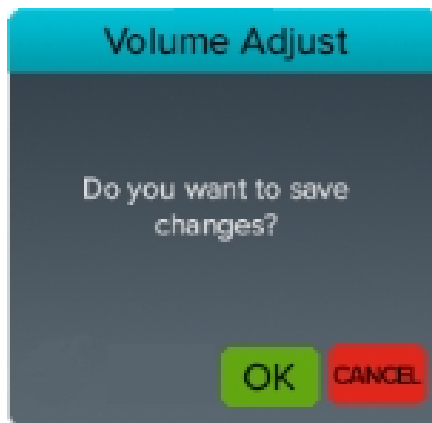

19. Touch OK.

Disabling Bubble Detection

The SpectraMax Injector cartridge has built-in detection for bubbles in the injector tubing to help maintain injection accuracy during your assays. The bubble sensor on the injector tubing detects breaks in the flow of conductive liquid within the tubing. It cannot detect breaks in non-conductive liquids, such as distilled water or ethanol.

You can disable bubble detection if the solution is somewhat gaseous.



CAUTION! Disabling bubble detection can cause sputtering at the tip that can contaminate the optics and samples inside of the plate chamber if the solution runs dry in the bottle or labware.

You should keep bubble detection enabled unless your assay requires it to be disabled. On the instrument Home screen:



- Displays when bubble detection is enabled. Touch to disable bubble detection.



- Displays when bubble detection is disabled. Touch to enable bubble detection.

Removing the Injector Cartridge

You do not need to remove the SpectraMax Injector cartridge when it is not in use. You must remove the SpectraMax Injector cartridge to do maintenance operations or when you pack the instrument for shipment. Store the cartridge in the box in which it was shipped in a dry, dust-free, controlled environment.



CAUTION! During a prime, rinse, or wash operation, and during a plate read, the nozzle that contains the injector tips and the optics lowers to 0.5 mm above the opening of the waste plate or the top of the plate to inject the reagent and to detect the luminescence signal. To prevent damage to the SpectraMax Injector cartridge, do not remove the cartridge when the nozzle is extended. To make sure that the nozzle is safely inside the cartridge, always return to the Home screen on the touchscreen before you start this procedure.

Before you remove the SpectraMax Injector cartridge, clear the injector tubing of all liquid.





CAUTION! To prevent damage to the installed detection cartridges and the instrument, do not manually slide the detection cartridge drawer in or out when the instrument is powered on or when one or more detection cartridges are installed in the drawer.

To remove the SpectraMax Injector cartridge:

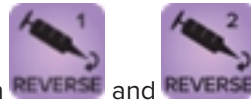

1. From the Home screen touch  to open the detection cartridge drawer.
To prevent damage to the SpectraMax Injector cartridge, always return to the Home screen before you start this procedure.



2. If you did not clear the injector lines, touch  and  on the touchscreen.
3. Remove the bottles from the bottle holder.
4. Place the end of a flat head screwdriver in the slot on the retaining clip and use it as a lever to unfasten all the retaining clips on both sides of the SpectraMax Injector cartridge.



5. Lift the SpectraMax Injector cartridge straight up off of the connector and holder pins on the detection cartridge slot.



6. Touch  to close the detection cartridge drawer.



7. Touch  to open the plate drawer.

8. Remove the waste plate and the strip wells.



9. Touch  to close the plate drawer.



CAUTION! To prevent dust from collecting inside the instrument, the detection cartridge drawer should be open only for as long as necessary to install or remove detection cartridges. Keep the detection cartridge drawer closed whenever possible.

Cleaning SpectraMax Injector Cartridge and Accessories



CAUTION! Do not clean the inside of the SpectraMax Injector cartridge other than the inside of the bottle holder. Cleaning the inside can cause damage to the cartridge.

Periodically clean the outside surfaces, the inside and outside of the bottle holder, the inside of the top cover, the snorkel clamps, and the snorkel end of the injector tubing using a lint-free cloth that has been lightly dampened with water. You can remove the bottle holder for cleaning. If decontamination is required, use a lint-free cloth that has been lightly dampened with a decontaminating solution, such as 70% ethanol or 3% sodium hypochlorite.



Note: After you use a decontamination solution, always wipe the areas with a lint-free cloth that is lightly dampened with water to remove the residue. If you use sodium hypochlorite, wipe the areas with a lint-free cloth that is lightly dampened with 70% alcohol before you wipe again with water.

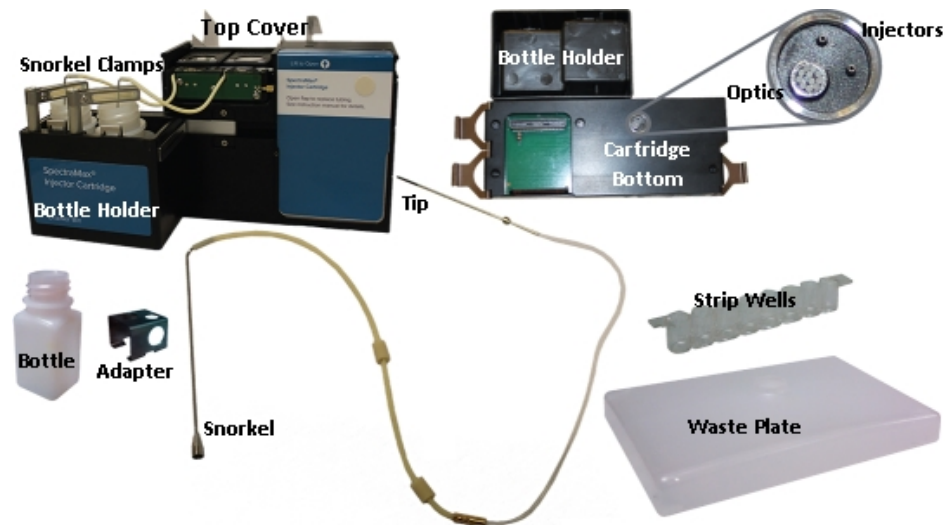

CAUTION! Do not use abrasive cleaners. Do not spray cleaner directly onto the cartridge or instrument. Do not immerse the SpectraMax Injector cartridge.

To clean the waste plate, strip wells, bottles, and adapters, use a lightly dampened, lint-free cloth. After you clean these accessories, let them air dry on absorbent paper or cloth. Invert the waste plate, strip wells, and bottles so that they drain as they dry.

To clean the injector tips and optics on the bottom of the cartridge, remove the bottles from the bottle holder and then place the cartridge on its long side with the bottle holder on top, so that you can see the bottom of the cartridge. Dab the surface of the injectors and optics using a lightly dampened, lint-free cloth. Do not insert anything into the injector tips as this can damage their internal non-stick coating.

To clean the inside of the injector tubing, use the Rinse or Wash operations.

Replacing Injector Tubing

Liquid moves through the injector tubing from the bottles to the tips. The lifetime of the tubing is limited, and you must replace the tubing when worn. The tubing volume counters keep track of how many micro liters (μL) of liquid have been dispensed through the tubing.

- After 2 L are dispensed through the tubing, a message appears to remind you that the tubing should be changed soon.
- After 3 L are dispensed through the tubing, you must change the tubing before you can use the injectors.



There are separate tubing lines for injector number 1 and injector number 2. You should replace both tubing lines at the same time.

Each tubing line includes a snorkel on one end and an injector tip on the other end. The snorkel is held in the bottle by an adjustable snorkel clamp. The tubing threads around the rotator and attaches to the housing with two rubber bumpers and a metal bubble sensor. The tip slides through the tip clamp in the isolation frame, and the tubing is held in position by the stabilizer.

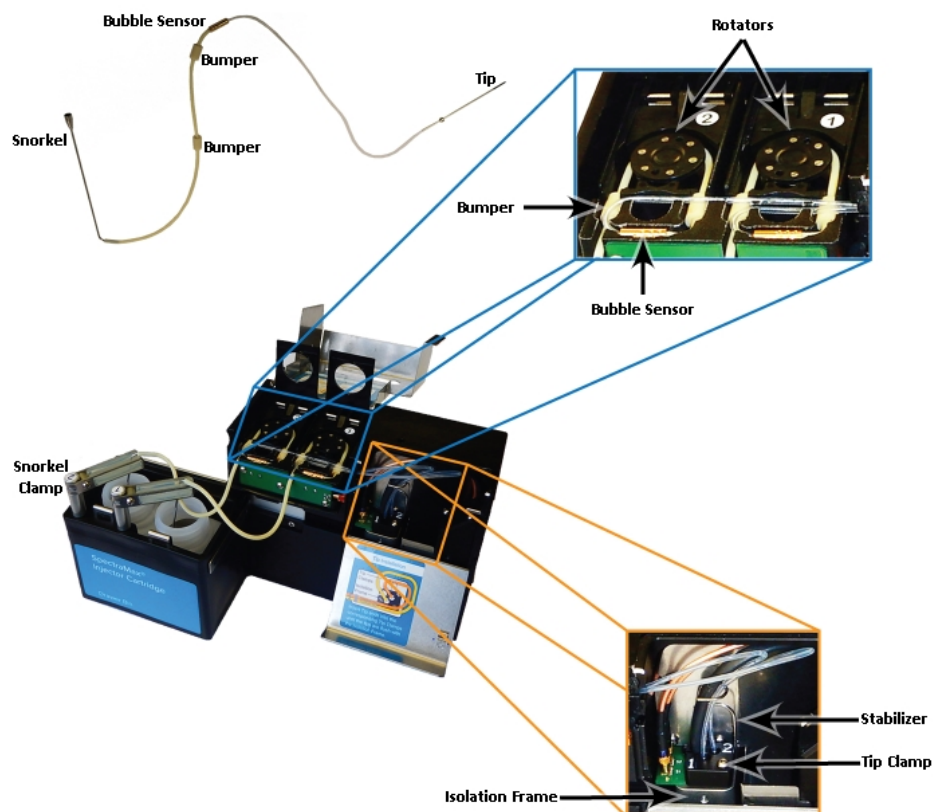

Note: Since the tubing for injector number 2 rests on top of the tubing for injector number 1, remove the tubing for injector number 2 before you remove the tubing for injector number 1. Also, install the tubing for injector number 1 before you install the tubing for injector number 2.

Opening SpectraMax Injector Cartridge

Before you open the SpectraMax Injector cartridge, remove the cartridge from the instrument.

1. Lift the top cover and swing it to its fully opened position.

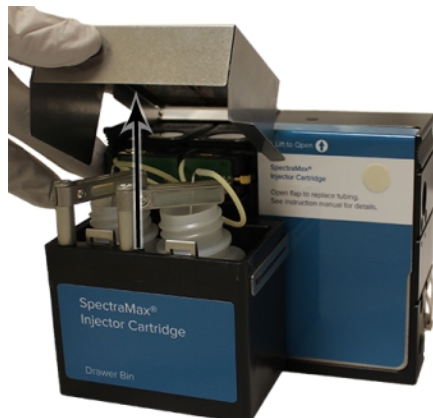

2. Slide the bottle holder away from the cartridge body.

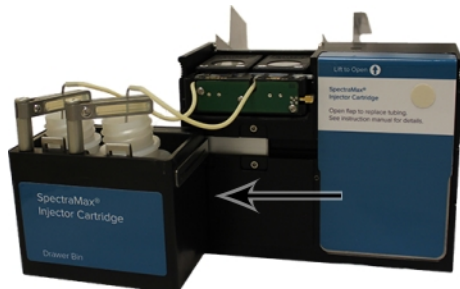

3. Lift the rotator covers to access both rotators.

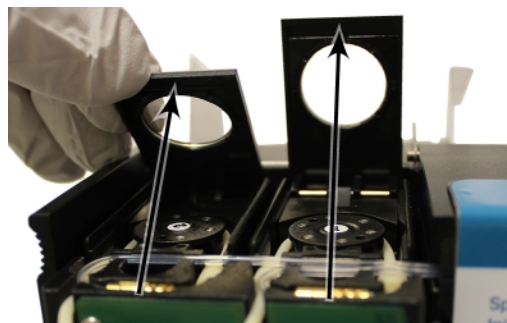

4. Press the round button on the front of the tip cover to release the inner latch, and then slide the cover upward and swing the cover to its fully opened position.

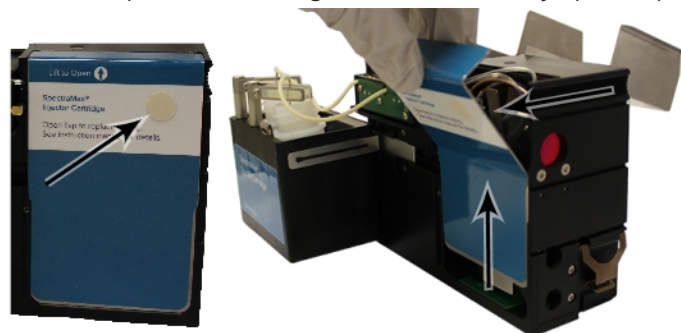

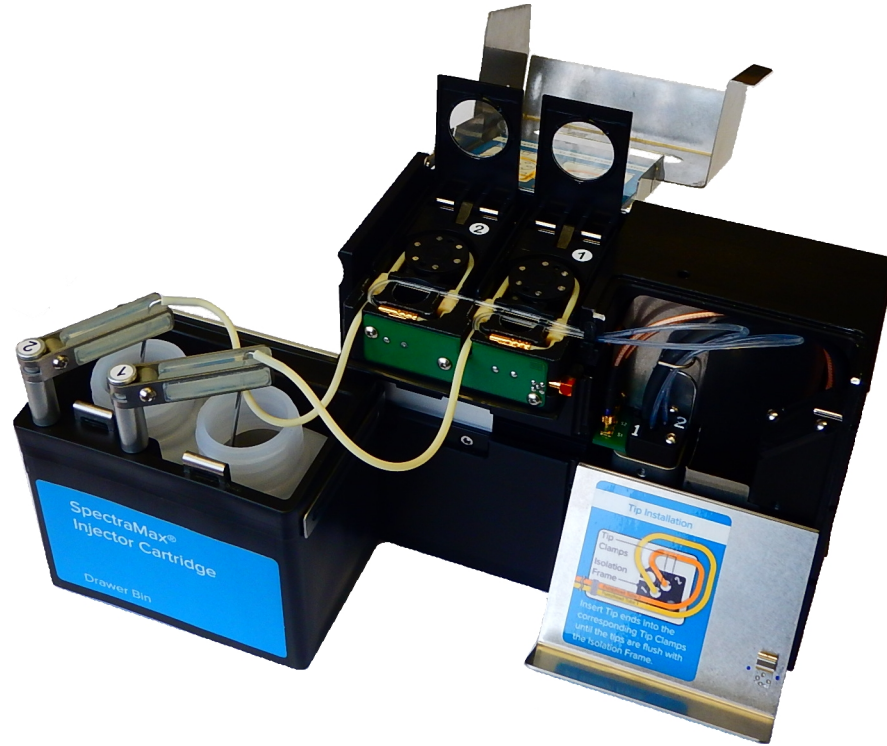

Removing Injector Tubing

The tubing for injector number 2 rests on top of the tubing for injector number 1. Remove the tubing for injector number 2 before you remove the tubing for injector number 1.

1. Slide the tip out of the tip clamp for injector number 2.

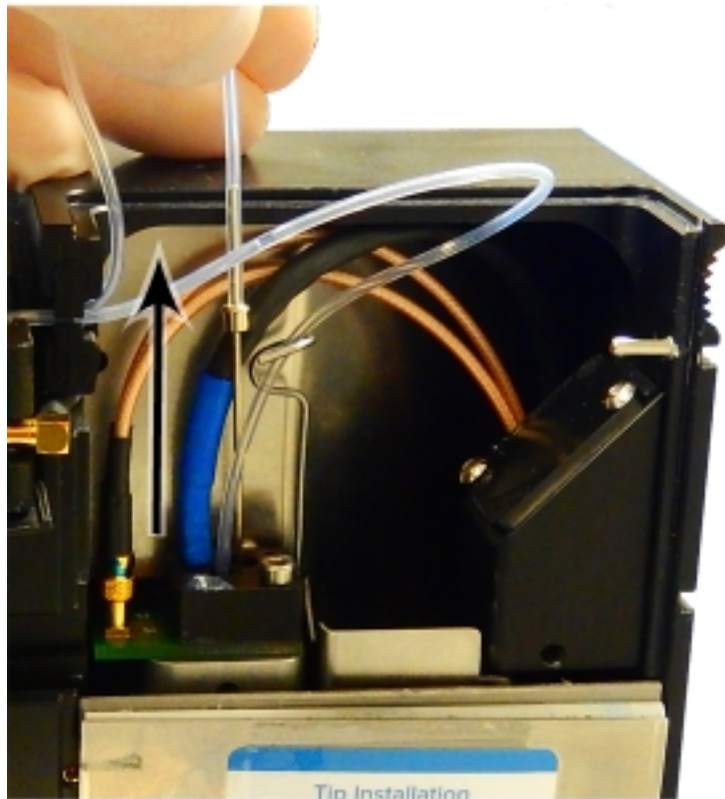

2. Unthread the tubing until you reach the metal bubble sensor.

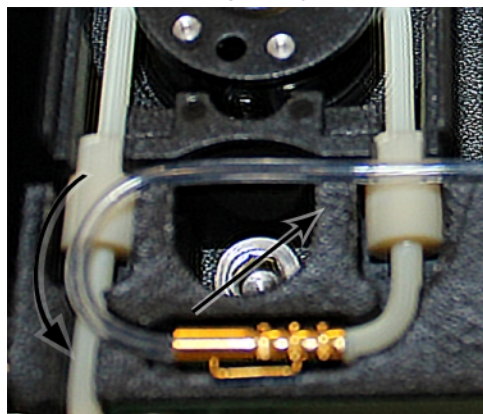

3. Gently disconnect the bubble sensor from the clip.

4. Gently pull the tubing away from the rotator, and then lift the bumper free of the bumper slot on the output side.

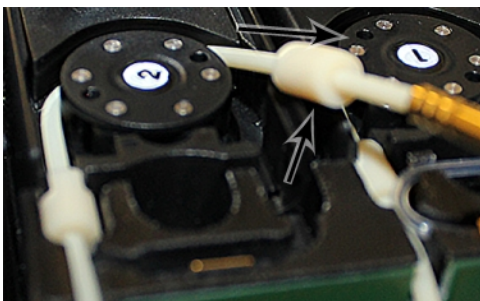

5. Unthread the tubing from around the rotator.
6. Gently pull the tubing away from the rotator, and then lift the bumper free of the bumper slot on the input side.
7. Slide the snorkel tube out of the open side of the snorkel clamp, and then slide the snorkel upward out of the bottle.

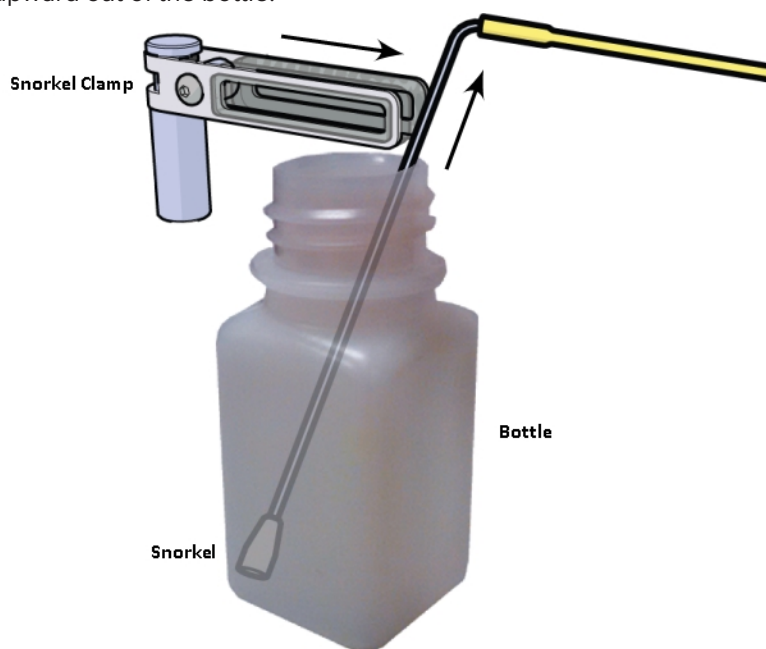

8. Discard the old tubing following the protocol of your laboratory.
9. After you remove the tubing for injector number 2, repeat this procedure to remove the tubing for injector number 1.

Installing Injector Tubing

Since the tubing for injector number 2 rests on top of the tubing for injector number 1, install the tubing for injector number 1 before you install the tubing for injector number 2.

1. Slide the snorkel all the way down into the bottle number 1, and then slide the tube into the open end of the snorkel clamp.

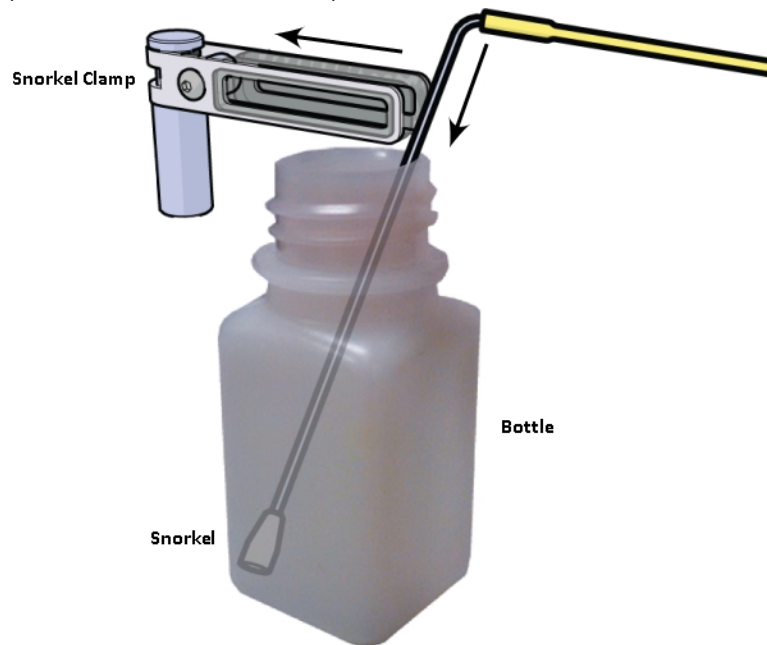

2. Press the bumper into the bumper slot on the input side of rotator number 1, and then gently pull the tubing toward the rotator to seat the bumper.

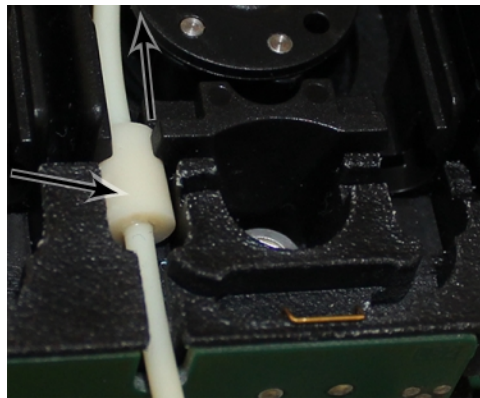

3. Thread the tubing around the rotator.
4. Gently pull the tubing away from the rotator, press the bumper into the bumper slot on the output side, and then release the tubing to seat the bumper.

5. Gently press the metal bubble sensor into the clip.

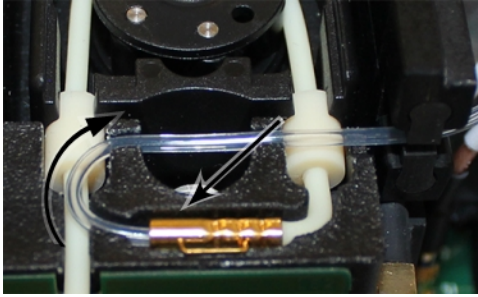

6. Thread the tubing through the channels and back toward the tip clamp.
7. Slide the tip through the loop in the stabilizer and into the tip clamp for injector number 1.

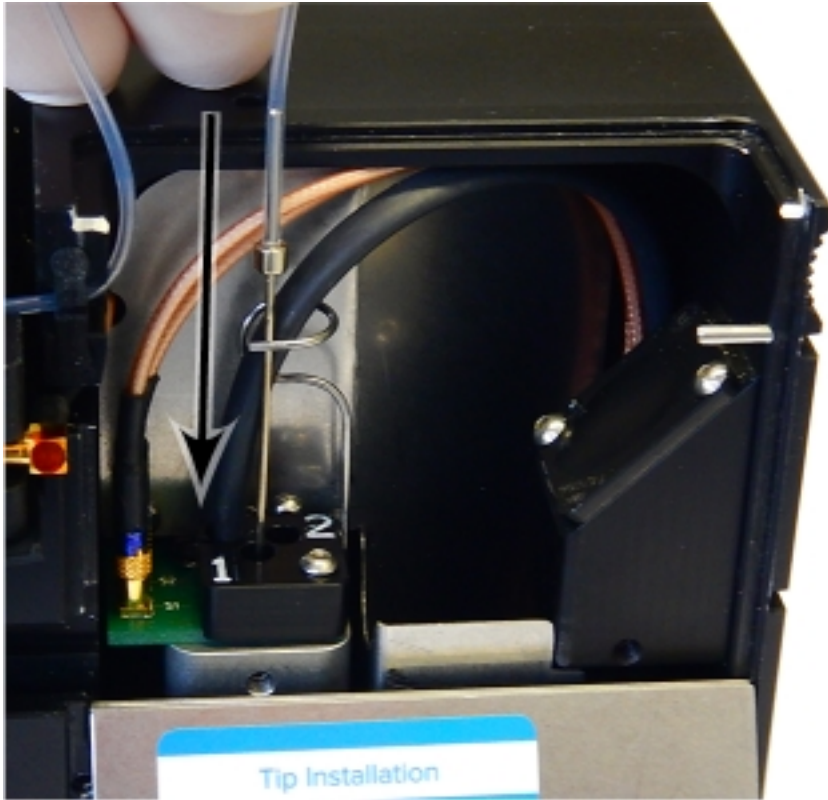

8. After you install the tubing for injector number 1, repeat this procedure to install the tubing for injector number 2.

Closing the SpectraMax Injector Cartridge

Before you install the SpectraMax Injector cartridge in the instrument, close all the access panels.

1. Thread the tubing through the slot between the rotators and the tip housing and then through the loop in the stabilizer.

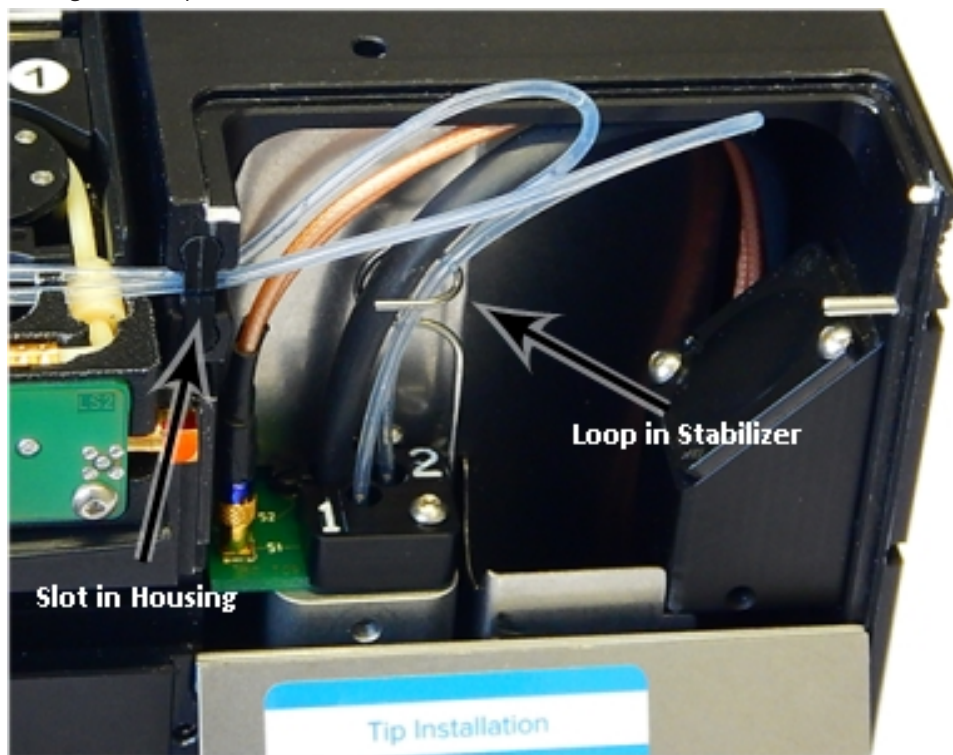

2. Slide the tip cover upward, swing the cover toward the body of the cartridge, and then slide the cover downward until it clicks into place.

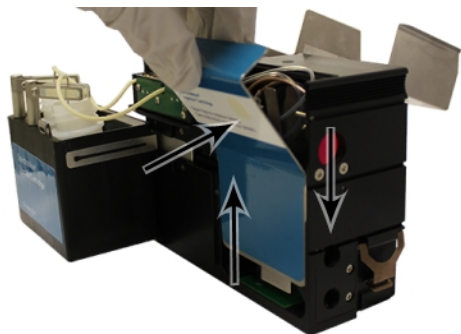

3. Press both rotator covers down to cover the rotators.

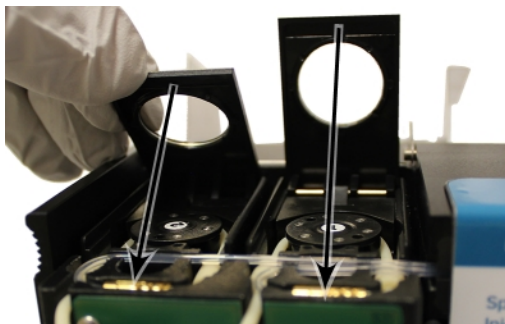

4. Slide the bottle holder back into place on the cartridge body.

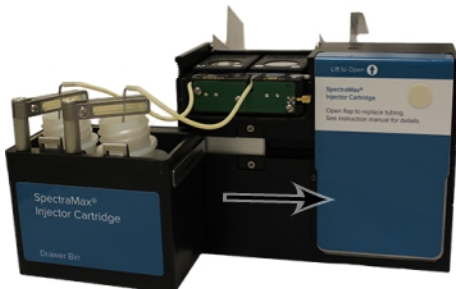

5. Swing the top cover to its fully closed position.



Resetting Tubing Volume Counters

The tubing volume counters keep track of how many micro liters (μL) of fluid pass through the tubing lines. After you replace the tubing, reset the counters to zero.

1. Install the SpectraMax Injector cartridge in the instrument.



2. From the Wash screen, touch  to display the Tubing Volume screen.



3. Touch  for the tubing you replaced. If you replace both sets of tubing, touch both



buttons to reset the counters to zero.

4. Touch  to display the Wash screen.

Replacing the Bottle Holder

To remove the bottle holder for replacement, lift it free of the pegs on the sliding bar.

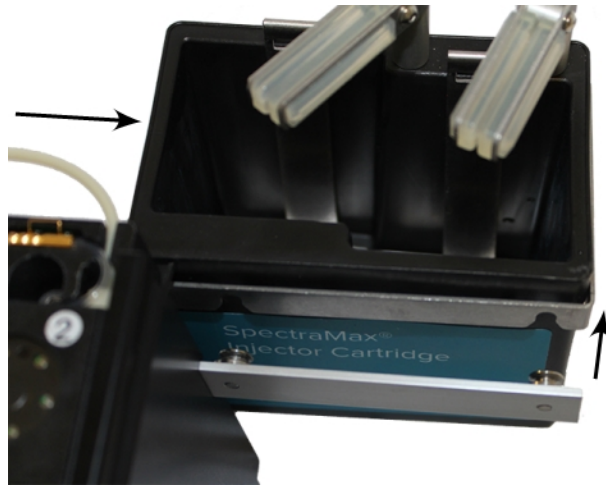

To remove the bottle holder:

1. Remove the SpectraMax Injector cartridge from the instrument.
2. Open the top cover.
3. Remove the snorkels from the bottles.
4. Remove the bottles from the bottle holder.
5. Slide the bottle holder away from the cartridge body.
6. Lift the bottle holder off the pegs on the sliding bar.

To install the bottle holder.

1. Slide the sliding bar away from the cartridge body.
2. Align the two slots on the bottle holder with the two pegs on the sliding bar.
3. Lightly press the bottle holder into position.
4. Insert the bottles in the bottle holder.
5. Insert the snorkels in the bottles.
6. Slide the bottle holder back into position.
7. Close the top cover.

Troubleshooting SpectraMax Injector Cartridge

Perform only the maintenance tasks described in this guide. Contact a Molecular Devices service engineer to inspect and perform a preventive maintenance service on the instrument each year. See [Obtaining Support on page 164](#).

Bubble Detection Error

The SpectraMax Injector cartridge has built-in detection for bubbles in the injector tubing to help maintain injection accuracy during your assays. The bubble sensor on the injector tubing detects breaks in the flow of conductive liquid within the tubing. It cannot detect breaks in non-conductive liquids, such as distilled water or ethanol.

To avoid bubble detection errors, degas your assay solution before use.

If a bubble detection error occurs, do the following:

1. Make sure that there is enough liquid in the bottle.
If the bottle is nearly empty, air can enter the tubing.
Fill the bottles with enough reagent for your experiment plus at least 2 mL to account for the prime operation and the quick-prime operation before the plate is read, and for the dead volume in the bottle and the tubing.
2. Inspect the tubing for visible bubbles.
3. Prime the injector tubing to push the bubbles out.
4. If bubbles are still present, hold down the rinse button until the bubbles are pushed out.
5. If bubbles are still present, reverse prime the injectors and then prime or rinse them again.

For some solutions, you might want to disable bubble detection, if the solution is somewhat gaseous.



CAUTION! Disabling bubble detection can cause sputtering at the tip that can contaminate the optics and samples inside of the plate chamber if the solution runs dry in the bottle or labware.

Overfill Detection Error

The overfill detection sensor in the cartridge optics helps to reduce the chance of spillage from dispensing too much liquid into a plate well.

To avoid overfill detection errors, make sure that the dispense volume you define in the software is less than the volume of the well minus the volume of the sample in the well. See the *SoftMax Pro Data Acquisition and Analysis Software User Guide* or the application help.

If an overfill detection error occurs, do the following:

- Clean the optical fibers on the bottom of the SpectraMax Injector cartridge.
- Make sure that the dispense volume you define in the software is less than the volume of the well minus the volume of the sample in the well.
- Make sure to specify the correct plate type in the software and that the plate definition is accurate.

Chapter 7: Read Modes and Read Types



7

The SpectraMax i3x can measure samples in absorbance (ABS), fluorescence intensity (FL), and luminescence (LUM) read modes.

The SpectraMax i3x supports user-installable detection cartridges to expand its read capabilities. Each detection cartridge contains the light source, optics, and electrical components needed to do specific read modes.

The SpectraMax MiniMax 300 Imaging Cytometer adds imaging capability to the SpectraMax i3x to visually inspect your sample and to run cell-based assays at cellular or whole-cell resolution.

Use the SoftMax Pro Software to define the parameters for the read mode and read type of your assay. See the *SoftMax Pro Data Acquisition and Analysis Software User Guide* or the application help.

Application notes with specific application protocol suggestions are in the Information Center and Knowledge Base on the Molecular Devices web site at www.moleculardevices.com.

- Absorbance Read Mode, see page 116
- AlphaScreen Read Mode, see page 120
- Fluorescence Intensity Read Mode, see page 122
- Fluorescence Polarization Read Mode, see page 126
- FRET Read Mode, see page 129
- HTRF Read Mode, see page 130
- Imaging Read Mode, see page 133
- Luminescence Read Mode, see page 135
- Time-Resolved Fluorescence Read Mode, see page 138
- Western Blot Read Mode, see page 142

Read Types

For most read modes, you can use the endpoint, kinetic, spectrum, and well scan read types.

Endpoint Read Type

For the endpoint read type, a read of each plate well is taken in the center of each well, at a single wavelength or at multiple wavelengths. Depending on the read mode, the software reports raw data values as optical density (OD), %Transmittance (%T), relative fluorescence units (RFU), or relative luminescence units (RLU).

Kinetic Read Type

For the kinetic read type, the instrument collects data over time with reads taken in the center of each well at regular intervals.

The values calculated based on raw kinetic data include VMax, VMax per Sec, Time to VMax, Onset Time, and more. Kinetic reads can be single-wavelength or multiple-wavelength reads.

Kinetic analysis can collect data points in time intervals of seconds, minutes, hours, or days. The kinetic read interval depends on the instrument setup parameters selected in the SoftMax Pro Software.

Kinetic analysis has many advantages when determining the relative activity of an enzyme in different types of plate assays, including ELISAs and the purification and characterization of enzymes and enzyme conjugates. Kinetic analysis can provide improved dynamic range, precision, and sensitivity relative to endpoint analysis.

Peak Pro™ Analysis functions provide advanced peak detection and characterization for applicable kinetic reads. See the *SoftMax Pro Data Acquisition and Analysis Software Formula Reference Guide*.

Membrane Read Type

The instrument uses the membrane read type for Time-Resolved Fluorescence reads of a Western Blot membrane. The software reads the area you select and generates a TIFF image with the results of the read.

The Molecular Devices ScanLater™ Western Blot Assay Kit is a novel system for protein analysis. Membranes are incubated with Eu-chelate labeled secondary antibodies or streptavidin that bind specifically to the target protein-specific primary antibody. For more information, contact your Molecular Devices representative or search the knowledge base for ScanLater or Western Blot at support.moleculardevices.com.

For information about the detection cartridge for Western Blot membrane reads, see [ScanLater Western Blot Detection Cartridge on page 68](#).

Spectrum Read Type

Depending on the read mode you select, the spectrum read type measures optical density (OD), %Transmittance (%T), relative fluorescence units (RFU), or relative luminescence units (RLU) across a spectrum of wavelengths.

Spectrum reads are made using the scanning monochromators of the instrument and can measure across the spectrum of absorbance wavelengths 230 nm to 1000 nm. Fluorescent intensity reads scan excitation wavelengths between 250 nm to 830 nm and emission wavelengths between 270 nm to 850 nm, where the emission wavelength must be a minimum of 20 nm greater than the excitation wavelength. Luminescence reads scan emission wavelengths between 300 nm to 850 nm.

Well Scan Read Type

The well scan read type takes reads at more than one location within a well. The well scan read type takes multiple reads of a single well of a plate on an evenly spaced pattern inside of each well at single or multiple wavelengths.

For applications that involve the detection of cells in large area tissue culture plates, the well scan read type permits maximum surface area detection in cell-based protocols. Since many cell lines tend to grow as clumps or in the corners of plate wells, you can choose the well scan pattern and define the number of points to scan in order achieve the best results.

The following scanning patterns are available:

- A horizontal line (Row or Well read order)
- A vertical line (Column read order)
- A cross pattern
- A fill pattern

The fill pattern can be either round or square to match the shape of the well. The image in the Well Scan settings shows the shape of the well as defined for the selected plate.

You can set the density of the well scan to determine the number of points to read in a line pattern or the maximum number of horizontal and vertical points included in a cross or fill pattern.

Depending on the read mode selected, the values are reported as optical density (OD), %Transmittance (%T), relative fluorescence units (RFU), or relative luminescence units (RLU).

Absorbance Read Mode

The instrument uses the Absorbance (ABS) read mode to measure the Optical Density (OD) of the sample solutions.

Absorbance is the quantity of light absorbed by a solution. To measure absorbance accurately, it is necessary to eliminate light scatter. If there is no turbidity, then absorbance = optical density.

$$A = \log_{10}(I_0 / I) = -\log_{10}(I/I_0)$$

where I_0 is intensity of the incident light before it enters the sample divided by the light after it passes through the sample, and A is the measured absorbance.

The temperature-independent PathCheck technology normalizes absorbance values to a 1 cm path length based on the near-infrared absorbance of water.

The instrument allows you to choose whether to display absorbance data as Optical Density (OD) or %Transmittance (%T).

Optical Density

Optical density (OD) is the quantity of light passing through a sample to a detector relative to the total quantity of light available. Optical Density includes absorbance of the sample plus light scatter from turbidity and background. You can compensate for background using blanks.

A blank well contains everything used with the sample wells except the chromophore and sample-specific compounds. Do not use an empty well for a blank.

Some applications are designed for turbid samples, such as algae or other micro-organisms in suspension. The reported OD values for turbid samples are likely to be different when read by different instruments.

For optimal results, you should run replicates for all blanks, controls, and samples. In this case, the blank value that will be subtracted is the average value of all blanks.

% Transmittance

%Transmittance is the ratio of transmitted light to the incident light for absorbance reads.

$$T = I/I_0$$

$$\%T = 100T$$

where I is the intensity of light after it passes through the sample and I_0 is incident light before it enters the sample.

Optical Density and %Transmittance are related by the following formulas:

$$\%T = 10^{2-OD}$$

$$OD = 2 - \log_{10}(\%T)$$

The factor of two comes from the fact that %T is expressed as a percent of the transmitted light and $\log_{10}(100) = 2$.

When in %Transmittance analysis mode, the instrument converts the raw OD values reported by the instrument to %Transmittance using the above formula. All subsequent calculations are done on the converted numbers.

Applications of Absorbance

Absorbance-based detection is commonly used to evaluate changes in color or turbidity, permitting widespread use including ELISAs, protein quantitation, endotoxin assays, and cytotoxicity assays. With absorbance readers that are capable of measuring in the ultraviolet (UV) range, the concentration of nucleic acids (DNA and RNA) can be found using their molar extinction coefficients.

For micro-volume measurements, you can use SpectraDrop 24-well Low Volume Microplate and SpectraDrop 64-well Low Volume Microplate.

PathCheck Technology

The temperature-independent PathCheck technology normalizes absorbance values to a 1 cm path length based on the near-infrared absorbance of water.

The Beer–Lambert law states that absorbance is proportional to the distance that light travels through the sample:

$$A = \epsilon cL$$

where A is the absorbance, ϵ is the molar absorptivity of the sample, c is the concentration of the sample, and L is the pathlength. The longer the pathlength, the higher the absorbance.

Microplate readers use a vertical light path, so the distance of the light through the sample depends on the volume. This variable pathlength makes it difficult to do extinction-based assays and makes it confusing to compare results between microplate readers and spectrophotometers.

The standard pathlength of a 1 cm cuvette is the conventional basis to quantify the unique absorptivity properties of compounds in solution. Quantitative analysis can be done on the basis of extinction coefficients, without standard curves (for example, NADH-based enzyme assays). When you use a cuvette, the pathlength is known and is independent of sample volume, so absorbance is directly proportional to concentration when there is no background interference.

In a plate, pathlength is dependent on the liquid volume, so absorbance is proportional to both the concentration and the pathlength of the sample. Standard curves are often used to determine analyte concentrations in vertical-beam photometry of unknowns, yet errors can still occur from pipetting the samples and standards. The PathCheck technology determines the pathlength of aqueous samples in the plate and normalizes the absorbance in each well to a pathlength of 1 cm. This way of correcting the microwell absorbance values can be accurate to within $\pm 4\%$ of the values obtained directly in a 1 cm cuvette.

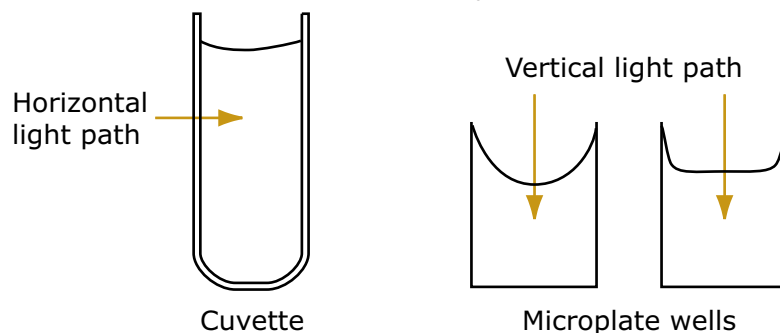

PathCheck technology normalizes the data acquired from an absorbance read mode endpoint read type to a 1 cm pathlength, correcting the OD for each well to the value expected if the sample were read in a 1 cm cuvette. The instrument uses the factory installed water constant to obtain the 1 cm values.



Note: You must select the PathCheck check box before a read because you cannot apply the PathCheck technology after the read. After you read a plate with PathCheck technology turned on, the software stores PathCheck information permanently within the document.

Water Constant

The PathCheck technology is based on the absorbance of water in the near infrared spectral region (between 900 nm and 1000 nm). If the sample is completely aqueous, has no turbidity and has a low salt concentration (less than 0.5 M), the water constant correction method is sufficient. The water constant is determined for each instrument during manufacture and is stored in the instrument.



Note: The cuvette reference correction method that the software uses with the PathCheck technology is different from the reference read of a cuvette that occurs when you click the Ref button in the Cuvette Set section tool bar.

Eliminating the Pathlength-Independent Component

Raw OD measurements of plate samples include both pathlength-dependent components (sample and solvent) and a pathlength-independent component (OD of plate material). The pathlength-independent component must be eliminated from the calculation to get valid results that have been normalized by the PathCheck technology. You can do this using a plate blank or using a plate background constant.

Using Plate Blanks

You can use this method if all samples in the plate are the same volume, and the read does not depend on the PathCheck technology to correct for variability in volumes.

To use a plate blank:

1. Designate a minimum of one well (preferably several) as Plate Blank.
2. Pipette buffer (for example, your sample matrix) into those wells and read along with the samples. Do not use an empty well for a blank.

The instrument automatically subtracts the average of the blank wells from each of the samples. The OD of the plate material is subtracted as part of the blank.

3. Select the Use Plate Blank check box in the Data Reduction dialog.

Using Plate Background OD

If your sample volumes are not identical or if you choose not to use a Plate Blank, then you must use a Plate Background OD. Omitting a Plate Background OD results in artificially high values after being normalized by the PathCheck technology.

To determine the Plate Background OD:

1. Fill a clean plate with water.
2. Read at the wavelengths you will use for the samples.

The average OD value is the Plate Background OD. If you intend to read your samples at more than one wavelength, there should be a corresponding number of Plate Background OD values for each wavelength.



Note: It is important that you put water in the wells and do not read a dry plate for the Plate Background OD. A dry plate has a slightly higher OD value than a water filled plate because of differences in refractive indices. Use of a dry plate results in PathCheck technology normalized values that are lower than 1 cm cuvette values.

Interfering Substances

Material that absorbs in the 900 nm to 1000 nm spectral region could interfere with PathCheck technology measurements. Fortunately, there are few materials that do interfere at the concentrations generally used.

Turbidity is the most common interference. If you can detect turbidity in your sample, you should not use the PathCheck technology. Turbidity elevates the 900 nm measurement more than the 1000 nm measurement and causes an erroneously low estimate of pathlength. Use of the Cuvette Reference does not reliably correct for turbidity.

Samples that are highly colored in the upper-visible spectrum might have absorbance that extends into the near-infrared (NIR) spectrum and can interfere with the PathCheck technology. Examples include Lowry assays, molybdate-based assays, and samples that contain hemoglobins or porphyrins. In general, if the sample is distinctly red or purple, you should check for interference before you use the PathCheck technology.

To determine possible color interference:

- Measure the OD at 900 nm and 1000 nm (both measured with air reference).
- Subtract the 900 nm value from the 1000 nm value.

Do the same for pure water.

If the delta OD for the sample differs significantly from the delta OD for water, then you should not use the PathCheck technology.

Organic solvents could interfere with the PathCheck technology if the solvents have absorbance in the region of the NIR water peak. Solvents such as ethanol and methanol do not absorb in the NIR region, so the solvents do not interfere, except to cause a decrease in the water absorbance to the extent of their presence in the solution. If the solvent absorbs between 900 nm and 1000 nm, the interference would be similar to the interference of highly colored samples. If you add an organic solvent other than ethanol or methanol, you should run a Spectrum scan between 900 nm and 1000 nm to determine if the solvent would interfere with the PathCheck technology.

AlphaScreen Read Mode

To use this read mode, you must install an applicable detection cartridge in the instrument.

ALPHA stands for Amplified Luminescent Proximity Homogeneous Assay. AlphaScreen® is a bead-based chemistry used to study molecular interactions between moieties A and B, for example. When a biological interaction between A and B moves beads (coated with A and B, respectively) together, a cascade of chemical reactions produce a greatly amplified signal.

The cascade result signal is triggered by laser excitation (680 nm), that makes a photosensitizer on the A-beads convert oxygen to an excited (singlet) state. The energized oxygen diffuses away from the A-bead. When reaching the B-bead in close proximity, it reacts with a thioxene derivative on the B-bead to generate chemiluminescence at 370 nm. Energy transfer to a fluorescent dye on the same bead shifts the emission wavelength into the 520 nm to 620 nm range. The limited lifetime of singlet oxygen in solvent (~4 microseconds) lets diffusion reach up to only around 200 nm distance. Thus, only B-beads in the proximity of A-beads yield signal, which indicates binding between moieties A and B.

An AlphaScreen measurement includes a light pulse, by turning on the laser diode for a specified time, turning off the laser diode, followed by the measurement of the AlphaScreen signal, as specified in the measurement protocol timing parameters.

AlphaScreen beads are light sensitive. Beads are best handled under subdued (<100 lux) or green filtered (Roscolux filters #389 from Rosco, or equivalent) light conditions. Do incubation steps in the dark.

You can normalize the raw data to counts per second.

Applications of AlphaScreen

Examples of AlphaScreen assays include:

- G-protein coupled receptor (GPCR) assay kits, for cAMP quantification or IP3 quantification.
- Tyrosine Kinase assays.
- Cytokine detection kits, such as TNF-alpha detection (immunoassay).

AlphaScreen read mode can capture the Europium emission line of AlphaLISA®.

To do AlphaScreen reads, the instrument requires [AlphaScreen Detection Cartridges](#), see page 54.

For more information, go to www.perkinelmer.com.

ALPHASCREEN and ALPHALISA are registered trademarks of PerkinElmer, Inc.

Analyzing AlphaScreen Data

The conversion rate of photons to counts and relative fluorescence units (RFU) is individual for each reader. Therefore, raw data from the same plate can seem to be different from one instrument to the next. Also, the data format used by instrument manufacturers might be counts normalized per second or not normalized counts, and therefore the raw data can be different by several orders of magnitude. It is important to know that the number of counts and the size of figures are not indicators of sensitivity.

The raw data can be normalized to counts per second by selecting the Normalization option on the Settings dialog.

Background Correction

Although background is significantly lower than with fluorescence intensity measurements, you should use blanks or assay controls for background correction. The background can be effectively measured using blank replicates. When you read a sample with small signal, an interference can occur from the afterglow of a very strong emitting adjacent sample that was measured just before. Such cross talk can occur through the wall of a white 384-well plate. To prevent such interference, you can select the Interlaced Read option in the Settings dialog. This option reads only every other well in a checkerboard pattern, and then reads the plate again to read the previously omitted wells.

A blank well contains everything used with the sample wells except the label and sample-specific compounds. Do not use an empty well for a blank.

For optimal results, you should run replicates for all blanks, controls, and samples. In this case, the blank value that will be subtracted is the average value of all blanks.

Detection Limit

The detection limit is the smallest sample concentration that can be detected reliably above the blank. Determining the detection limit requires taking a number of blank measurements and calculating an average value and standard deviation for the blanks. The detection threshold is defined as the average blank plus three standard deviations. If the average sample value measures above the threshold, the sample can be detected at a statistically significant level.

The detection limit can be described by the following equation:

$$\text{Det Limit} = \frac{3 \text{ StDev}_{\text{blank}}}{\left(\frac{\text{std-blank}}{\text{conc}_{\text{std}}} \right)}$$

where conc_{std} is the concentration of the standard, $\text{StDev}_{\text{Blank}}$ is the standard deviation of the blank replicates, and blank and std are average values of the replicates for the blank and standard wells.

Data Qualification and Validation

Z' is the standard statistical parameter in the high-throughput screening community to measure the quality of a screening assay independent of test compounds. Use this as a measure of the signal separation between the positive controls and the negative controls in an assay.

Use the following formula to determine the value of Z' :

$$Z' = 1 - \frac{3(\text{SD}_{\text{c}+}) + 3(\text{SD}_{\text{c}-})}{|\text{Mean}_{\text{c}+} - \text{Mean}_{\text{c}-}|}$$

where **SD** is the standard deviation, **c+** is the positive control, and **c-** is the negative control.

A Z' value greater than or equal to 0.4 is the generally acceptable minimum for an assay. You can use higher values when results are more critical.

Z' is not linear and can be made unrealistically small by outliers that skew the standard deviations in either population. To improve the Z' value, increase the quantity of label in the sample, if acceptable for the assay, or increase the read time per well.



Note: The assay plate and the instrument should be kept at room temperature, since temperature variations cause fluctuations in signal.

Fluorescence Intensity Read Mode

Fluorescence occurs when absorbed light is re-radiated at a longer wavelength. In the Fluorescence Intensity read mode, the instrument measures the intensity of the re-radiated light and expresses the result in Relative Fluorescence Units (RFU).

The governing equation for fluorescence is:

$$\text{Fluorescence} = \text{extinction coefficient} \times \text{concentration} \times \text{quantum yield} \times \text{excitation intensity} \times \text{pathlength} \times \text{emission collection efficiency}$$

Fluorescent materials absorb light energy of a characteristic wavelength (excitation), undergo an electronic state change, and instantaneously emit light of a longer wavelength (emission). Most common fluorescent materials have well-characterized excitation and emission spectra. The following figure shows an example of excitation and emission spectra for a fluorophore. The excitation and emission bands are each fairly broad with half-bandwidths of approximately 40 nm, and the difference between the wavelengths of the excitation and emission maxima (the Stokes shift) is generally fairly small, about 30 nm. There is considerable overlap between the excitation and emission spectra (gray area) when a small Stokes shift is present.

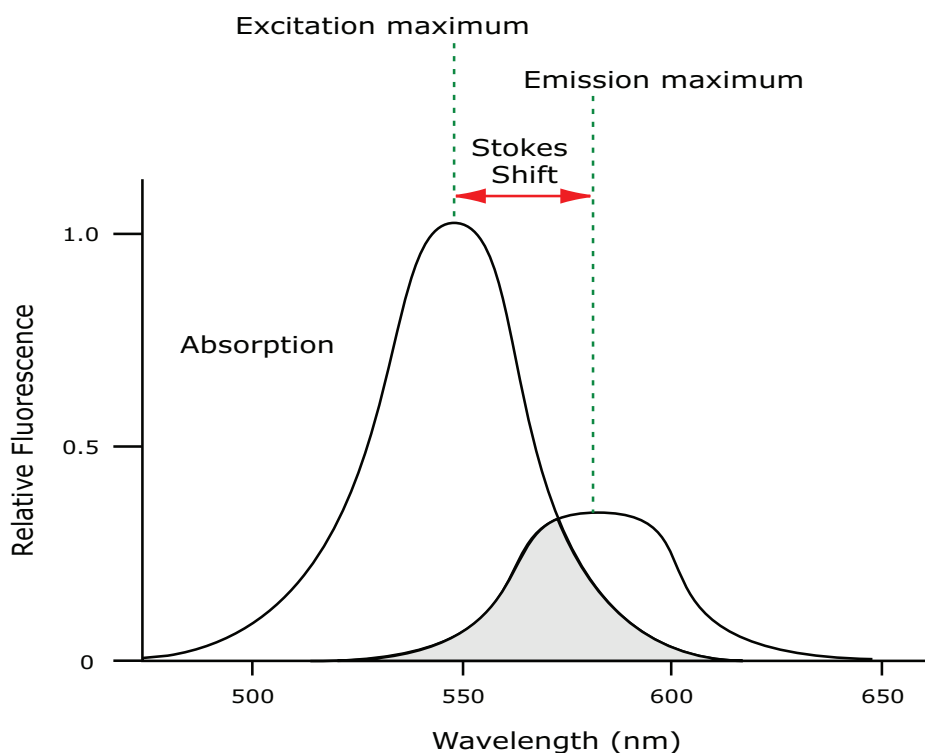

Excitation and Emission Spectra

Because the intensity of the excitation light is usually many tens of thousands of times greater than that of the emitted light, you must have sufficient spectral separation to reduce the interference of the excitation light with detection of the emitted light.

*** Tip:** If the Stokes shift is small, you should choose an excitation wavelength that is as far away from the emission maximum as possible while still able to stimulate the fluorophore so that less of the excited light overlaps the emission spectrum, which permits better selection and quantitation of the emitted light.

The Spectral Optimization wizard provides the best method to maximize the signal to background window (S-B)/B while minimizing the optimization time.

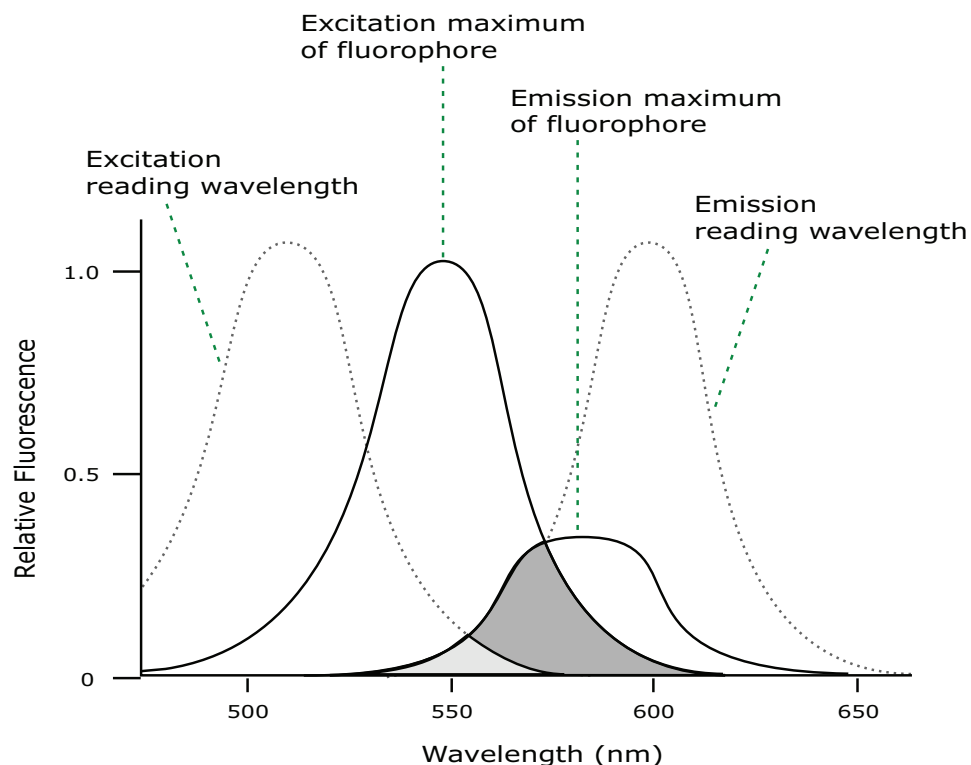

Optimized Excitation and Emission Read Wavelengths

The previous figure shows that the best results are often obtained when the excitation and emission wavelengths you use for the read are not the same as the peak wavelengths of the excitation and emission spectra of the fluorophore. When the read wavelengths for excitation and emission are separated, a smaller quantity of excitation light passes through to the emission monochromator (gray area) and on to the PMT, which results in a purer emission signal and more accurate data.

The instrument allows you to scan both excitation and emission wavelengths, using separate tunable dual monochromators. One benefit of scanning emission spectra is that you can determine more accurately whether the emission is, in fact, the expected fluorophore, or multiple fluorophores, and not one generated by a variety of background sources or by contaminants. One more benefit is that you can find excitation and emission wavelengths that prevent interference when interfering fluorescent species are present.

For this reason, it is desirable to scan emission for both an intermediate concentration of labeled sample, as well as the background of unlabeled sample. The optimal setting is where the ratio of the sample emission to background emission is at the maximum.

Fluorescence intensity data is dependent on several variables.

Applications of Fluorescence Intensity

Fluorescence intensity is used widely in applications such as fluorescent ELISAs, protein assays, nucleic acid quantitation, reporter gene assays, cell viability, cell proliferation, and cytotoxicity. One more major application is to study the kinetics of ion release.

Some assays use a fluorescent label to selectively attach to certain compounds. The quantity or concentration of the compound can then be quantified by measuring the fluorescence intensity of the label, which is attached to the compound. Such methods are often used to quantify low concentrations of DNA or RNA, for example.

The SpectraMax i3x supports user-installable detection cartridges to expand its read capabilities. Each detection cartridge contains the light source, optics, and electrical components needed to do specific read modes.

Fluorescence Intensity Reads with Injectors

Injectors deliver a specified volume of a reagent to the wells of a plate. You generally use injectors when delivery of the reagent initiates a reaction that occurs rapidly and results in a luminescent or fluorescent signal that you must quickly detect.

Common inject-and-read assays include calcium flux assays.

When you install the SpectraMax Injector cartridge in the SpectraMax i3x, you can create a protocol to inject and read well by well to reduce signal loss.

Background Correction and Quantification

A blank well contains everything used with the sample wells except the label and sample-specific compounds. Do not use an empty well for a blank.

The blank sample reveals the offset underlying each data sample. This offset does not carry information on the label and is generally subtracted before data reduction is done.

Within the linear detection range, the blank-subtracted raw data are proportional to the quantity of label in a sample such that the label concentration is quantified by the following equation.

$$\text{conc}_{\text{label}} = \frac{(\text{sample-blank})}{\left(\frac{\text{std-blank}}{\text{conc}_{\text{std}}}\right)}$$

where conc_{std} is the concentration of the *standard*, and *sample*, *blank*, and *std* are average values of replicates for the sample, blank, and standard wells. In the general case where the standard curve covers a concentration range of more than a few linear logs, $(\text{std} - \text{blank}) / \text{conc}_{\text{std}}$ is equivalent to the slope of the standard curve, and so the concentration of the label is determined by $(\text{sample} - \text{blank}) / (\text{slope of standard curve})$.

For optimal results, you should run replicates for all blanks, controls, and samples. In this case, the blank value that will be subtracted is the average value of all blanks.

Detection Limit

The detection limit is the smallest sample concentration that can be detected reliably above the blank. Determining the detection limit requires taking a number of blank measurements and calculating an average value and standard deviation for the blanks. The detection threshold is defined as the average blank plus three standard deviations. If the average sample value measures above the threshold, the sample can be detected at a statistically significant level.

The detection limit can be described by the following equation:

$$\text{Det Limit} = \frac{3 \text{ StDev}_{\text{blank}}}{\left(\frac{\text{std-blank}}{\text{conc}_{\text{std}}} \right)}$$

where conc_{std} is the concentration of the standard, $\text{StDev}_{\text{Blank}}$ is the standard deviation of the blank replicates, and blank and std are average values of the replicates for the blank and standard wells.

Determining detection limits for assays requires multiple blanks to calculate their standard deviation.

Linearity and the Linear Dynamic Range

Within a wide range at moderately high concentrations, blanked raw data is proportional to the quantity of label in a sample.

The linear dynamic range (LDR) is defined by:

$$\text{LDR} = \log_{10} \left(\frac{\text{max conc lin}}{\text{detection limit}} \right)$$

where LDR is expressed as a log, and max conc lin is the highest concentration in the linear range that can be quantified.

When the standard curve after blank reduction is not linear in concentration at the lower end, there might be an incorrect or contaminated blank.

When the standard curve levels are off at the highest concentrations, this can be addressed to the inner filter effect: excitation does not reach as deep into the sample for lower concentrations, without being more significantly attenuated (absorbance) layer by layer.

Fluorescence Polarization Read Mode

To use this read mode, you must install an applicable detection cartridge in the instrument.

The Fluorescence Polarization (FP) read mode measures the relative change of polarization of emitted fluorescence compared to excitation light.

Fluorescence Polarization detection is based on Fluorescence Intensity, with the important difference that it uses plane-polarized light, rather than non-polarized light. Microplate readers measure the Fluorescence Polarization of the sample by detecting light emitted both parallel and perpendicular to the plane of excitation.

By using a fluorescent dye to label a small molecule, the binding of a small molecule to an interaction partner of equal or greater size can be monitored through its speed of rotation.

When molecules are excited with polarized light, the change in the polarization of the emitted light depends on the size of the molecule to which the fluorophore is bound (the emitted light quickly depolarizes if the fluorescent molecule is unbound). Larger molecules yield a stronger polarization of the emitted light, while smaller molecules cause less polarization because of their rapid molecular movement. Use Fluorescence Polarization for molecular binding assays in high-throughput screening (HTS).

Applications of Fluorescence Polarization

Fluorescence Polarization measurements provide information on molecular mobility and are generally used to quantify the success of a binding reaction between a smaller labeled ligand and a binding site at a much larger or immobilized molecule. Use Fluorescence Polarization to quantify the dissociation or cleavage of the labeled ligand from a binding site.

Fluorescence Polarization is a homogeneous plate assay technique and requires only mixing and measuring—no wash steps are required as in an ELISA. It can also be miniaturized, which makes it useful for high-throughput screening applications.

The following detection cartridge has Fluorescence Polarization read mode capability:

- [Fluorescence Polarization Detection Cartridges, see page 59](#)

Analyzing Fluorescence Polarization Data

The Fluorescence Polarization read mode returns two sets of data: one for fluorescence intensity parallel (P) to the excitation plane, and the other for fluorescence intensity perpendicular (S) to the excitation plane. The software uses the S and P values to calculate the Polarization (mP) and Anisotropy (r) values.

Fluorescence Polarization assays in plates are generally designed with two control samples:

- LOW control sample: minimal polarization value resulting from unbound labeled ligand only
- HIGH control sample: maximum polarization value resulting from bound labeled ligand only

The Fluorescence Polarization data for a sample is evaluated based on its relative position between the low and high control values. Total intensity can also be determined from the raw data and is proportional to the quantity of label in a sample.

Blank Correction

Many Fluorescence Polarization assays use small fluorescent label concentrations in the lower nm range. In this range, blank controls become significant when compared to samples.

A blank well contains everything used with the sample wells except the label and sample-specific compounds. Do not use an empty well for a blank.

Background wells, which contain all assay components minus the fluorophore, should be tested. If the signal in the background wells is more than 1/10 the signal in the wells that contain fluorophore, then background wells should be run on each assay plate. The average raw signal from the background's parallel and perpendicular reads must be subtracted from the raw parallel and perpendicular reads of each sample well before the mP calculation is done.

For optimal results, you should run replicates for all blanks, controls, and samples. In this case, the blank value that will be subtracted is the average value of all blanks.

Data Reduction

Although the raw S and P values are the true actual values returned from the instrument, the calculated Polarization (mP) and Anisotropy (r) values are treated as the raw data and become the basis for further reduction calculations.

Polarization (mP) is calculated as follows:

$$mP = 1000 * \frac{(\text{parallel} - (G * \text{perpendicular}))}{(\text{parallel} + (G * \text{perpendicular}))}$$

Anisotropy (r) is calculated as follows:

$$r = \frac{(\text{parallel} - (G * \text{perpendicular}))}{(\text{parallel} + (2G * \text{perpendicular}))}$$

Use the G factor, or grating factor, in Fluorescence Polarization to correct polarization data for optical artifacts which converts relative mP data to theoretical mP data. Optical systems, particularly with reflective components, pass light of different polarization with different efficiency. G factor corrects for this instrument-based bias.

Data Qualification and Validation

When you validate the data of a Fluorescence Polarization measurement and the assay, the two factors to look at are the precision value and the Z' factor.

The FP precision value is a measure of replicate uniformity determined by the standard deviation of replicates at a label concentration of 1 nM. Since the precision of a measured signal also depends on the read time, the read time must also be specified. A longer read time leads to a lower (better) precision value.

Z' is the standard statistical parameter in the high-throughput screening community to measure the quality of a screening assay independent of test compounds. Use this as a measure of the signal separation between the positive controls and the negative controls in an assay.

Use the following formula to determine the value of Z':

$$Z' = 1 - \frac{3(SD_{c+}) + 3(SD_{c-})}{| \text{Mean}_{c+} - \text{Mean}_{c-} |}$$

where **SD** is the standard deviation, **c+** is the positive control, and **c-** is the negative control.

A Z' value greater than or equal to 0.4 is the generally acceptable minimum for an assay. You can use higher values when results are more critical.

Z' is not linear and can be made unrealistically small by outliers that skew the standard deviations in either population. To improve the Z' value, increase the quantity of label in the sample, if acceptable for the assay, or increase the read time per well.

The assay window is dependent on the fluorophore lifetime and relative size of the receptor to the ligand. Precision values are better (lower) at higher signals, which normally come from higher label concentrations.

For a given assay window, Z' is a downward sloping linear function. That is, as precision values get higher (worse), the Z' value gets lower (worse).

Precision is dependent upon assay characteristics (sample volume, label concentration) and read time. In many assays, the characteristics are defined and cannot be changed. In this case, the only way to improve precision is to increase the read time per well.

FRET Read Mode

Fluorescence resonance energy transfer (FRET) is a distance-dependent interaction between the electronic excited states of two dye molecules in which excitation is transferred from a donor molecule to an acceptor molecule without emission of a photon.

FRET relies on the distance-dependent transfer of energy from a donor molecule to an acceptor molecule. Due to its sensitivity to distance, you can use FRET to investigate molecular interactions. FRET is the radiationless transmission of energy from a donor molecule to an acceptor molecule. The donor molecule is the dye or chromophore that initially absorbs the energy and the acceptor is the chromophore to which the energy is subsequently transferred. This resonance interaction occurs over greater than interatomic distances, without conversion to thermal energy, and without a molecular collision. The transfer of energy leads to a reduction in the fluorescence intensity and excited state lifetime of the donor, and an increase in the emission intensity of the acceptor. A pair of molecules that interact in such a manner that FRET occurs is often referred to as a donor/acceptor pair.

While there are many factors that influence FRET, the primary conditions that need to be met for FRET to occur are relatively few:

- The donor and acceptor molecules must be in close proximity to each other.
- The absorption or excitation spectrum of the acceptor must overlap the fluorescence emission spectrum of the donor.
The degree to which they overlap is referred to as the spectral overlap integral (J).
- The donor and acceptor transition must be approximately parallel.

The SpectraMax i3x supports user-installable detection cartridges to expand its read capabilities. Each detection cartridge contains the light source, optics, and electrical components needed to do specific read modes.

For the SpectraMax i3x and the SpectraMax Paradigm, See [FRET Detection Cartridges on page 61](#).

HTRF Read Mode

To use this read mode, you must install an applicable detection cartridge in the instrument.

Homogeneous time-resolved fluorescence (HTRF) is a measurement technique based on fluorescence resonance energy transfer (FRET) using the advantages of time-resolved fluorescence (TRF) read.

HTRF uses a donor fluorophore with a long fluorescence lifetime, such as Europium. The acceptor fluorophore acts as if it also has a long fluorescence lifetime. This lets the time-gating principle of time-resolved fluorescence be applied to the acceptor emission to separate specific signal from background and signal caused by compound interference.

Time-gating electronics introduce a delay between the flashes and the start of signal collection. During the delay, the unspecific fluorescence caused by test compounds, assay reagents, and the plate vanishes while only a small portion of the specific fluorescence from the acceptor fluorophore is sacrificed. Enough of the specific signal remains, with the benefit of reduced background.

Applications of Homogeneous Time-Resolved Fluorescence

Homogeneous time-resolved fluorescence (HTRF) is used in competitive assays to quantify the binding between two labeled molecules, or the disintegration of a bound complex. Binding partners can have similar molecular weights as opposed to fluorescence polarization read modes. HTRF is a homogeneous assay that requires only mixing and measuring—no wash steps are required. It can also be miniaturized, which makes it useful for high-throughput screening applications.

The fluorescence ratio related to the HTRF readout is a correction method developed by Cisbio, for which Cisbio has granted a license to Molecular Devices. Its application is strictly limited to the use of HTRF reagents and technology, excluding other TR-FRET technologies such as IMAP TR-FRET calculations of acceptor to donor ratios.

HTRF is a registered trademark of Cisbio Bioassays.

Analyzing HTRF Data

A Homogeneous Time-Resolved Fluorescence (HTRF) measurement includes a number of flash intervals. Each flash interval consists of flashing the lamp, pausing for a specified length of time, and measuring the fluorescence intensity of the sample. These flash intervals are repeated several times, as specified in the protocol parameters.

Data Reduction

Data reduction for HTRF reads consists of two steps.

First, a ratio of the signal measured by the emission from the acceptor label at 665 nm to the signal measured by the emission of the donor label at 616 nm is calculated and multiplied by a factor of 10,000. This generates what is called the HTRF ratio.

In the second step, ratios are calculated that represent the relative change in the HTRF signal compared to that of the assay background, represented by assay controls potentially named negative or Standard 0. This relative response ratio is called the Delta F and is formatted as a percentage, although values greater than 100 can be generated.

Data Optimization

Measurement noise is dependent on the read time per sample (time per plate or time per well). The detection limit improves when you increase the read time. It is important to enter the read time when you compare measurements. For TRF, the read time per well increases with the number of pulses you enter. The time between pulses can be different on various systems.

HTRF Timing Parameters Example

Parameter	Value	Comment
Number of pulses	30	Number of flashes per read.
Measurement delay	30 μ s	Delay to ensure excitation pulse is no longer detectable.
Integration time per cycle (pulse)	400 μ s	Period to accumulate the signal.

Defining the number of flashes (pulses) cannot be used for comparative purposes because the flash and intensity rate varies from system to system.

You can optimize two timing parameters to adjust the performance of the measurement: time per plate or time per well and integration time per cycle.

All low-light-level detection devices have some measurement noise in common. To average out the measurement noise, optimization of the time per well involves accumulating as many counts as possible. Within some range, you can reduce noise (CVs, detection limit) by increasing the read time per well, as far as is acceptable from throughput and sample stability considerations.

As the number of flashes (read time per well) is increased, several aspects of the data improve:

- Delta F values show less variability (better CVs).
- Small Delta F values are better distinguished from noise.
- Noise of background is reduced.

The second timing parameter you can optimize is the Integration time per cycle. Take care when you optimize the integration time to consider noise. Delta F is higher at low integration times, but noise is also high at low integration times. The optimal integration time is where noise is minimized while maximizing Delta F.

In the following example, the optimal integration time (read time per cycle) displays to be in the 500 μ s to 1000 μ s range, as noise is minimized and Delta F is still relatively high. Going greater than 1000 μ s shows a sharp decline in Delta F without apparent improvement in noise.

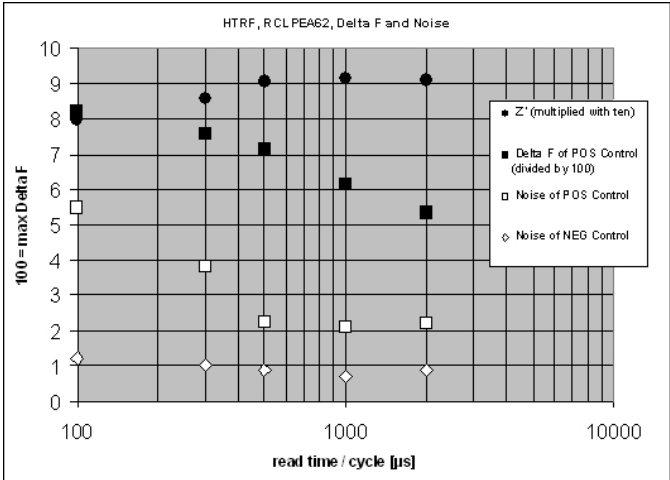

Relationship Between Integration Time, Noise, and Delta F

Z' is the standard statistical parameter in the high-throughput screening community to measure the quality of a screening assay independent of test compounds. Use this as a measure of the signal separation between the positive controls and the negative controls in an assay.

Use the following formula to determine the value of Z':

$$Z' = 1 - \frac{3(SD_{c+}) + 3(SD_{c-})}{|Mean_{c+} - Mean_{c-}|}$$

where **SD** is the standard deviation, **c+** is the positive control, and **c-** is the negative control.

A Z' value greater than or equal to 0.4 is the generally acceptable minimum for an assay. You can use higher values when results are more critical.

Z' is not linear and can be made unrealistically small by outliers that skew the standard deviations in either population. To improve the Z' value, increase the quantity of label in the sample, if acceptable for the assay, or increase the read time per well.

Imaging Read Mode

To use the Imaging read mode, you must install the SpectraMax i3x with the SpectraMax MiniMax 300 Imaging Cytometer. Imaging read mode does whole-cell imaging assays. You can obtain imaging data through visual inspection of the image or use the analysis tools in the SoftMax Pro Software.

Whole-cell imaging assays are cell-based, or object-based, rather than the single-point measurements found in other types of plate reads. These types of assays can yield more biologically meaningful results that can discriminate the fluorescence related to objects, such as cells or beads, from the bulk solution within a plate well.

The measurement is primarily fluorescent with quantification of cell size, shape, area, and intensity. Brightfield, transmitted light imaging supports label-free quantification. The camera resolution in the SpectraMax MiniMax 300 Imaging Cytometer is sufficient to determine the approximate shape of small 8 micron objects, such as blood cells.

These assays include the direct interrogation of individual cells instead of whole well or cell lysates which allows you to control cell numbers and heterogeneity in cell-based assays. Imaging provides increased sensitivity by detecting a few fluorescent cells per well and detecting cells that are, on average, less fluorescent.

The SpectraMax MiniMax 300 Imaging Cytometer can use transmitted light and two fluorescent channels during the same plate read to acquire image data. Use the Settings dialog to select the channels for the acquisition. The StainFree Cell Detection Algorithm uses proprietary transmitted light analysis technology to eliminate cell staining for cell counting and confluency measurements.

Applications of Whole-Cell Imaging

Whole-cell imaging assays measure a diverse set of cellular responses, such as fluorescent protein expression (phosphorylated and total), cell viability (cell toxicity), cell apoptosis, and cell cycle analysis.

The following dyes are supported:

- EarlyTox™ Cell Integrity Kit
- Fluorescein isothiocyanate (FITC)
- Calcein AM
- Alexa Fluor 488 or Alexa Fluor 647
- Cy5
- DRAQ5

Install the SpectraMax Transmitted Light (TL) detection cartridge in the detection cartridge drawer to do brightfield, transmitted-light imaging. See [Imaging - Transmitted Light Detection Cartridge on page 62](#).

Analyzing Imaging Data

You can obtain imaging data through visual inspection of the image or you can use the analysis tools in the SoftMax Pro Software.

In fluorescent imaging, the fluorescence in the sample is excited with light of a specified wavelength. The fluorophore emits at a longer wavelength that is captured in the image.

The software measures the intensity of the emitted fluorescence and estimates the intensity of the background in the image.

You can select one of the following image analysis types.

Discrete Object Analysis

Discrete Object Analysis uses proprietary algorithms to analyze objects, or cells, based on multiple parameters including the signal intensity over the background and the object size.

- Click **Find Objects** to enter size and intensity values or to use proprietary algorithms with the drawing tools to define the objects and the background areas for the analysis.
- Click **Classify Objects** to define separate measurements for different types of found objects, or cells.
- Click **Select Measurements** to view the results of the analysis for the wells you select.

Field Analysis

Field Analysis uses proprietary algorithms to analyze confluent areas based on parameters including the signal intensity over the background and the size of the areas.

- Click **Find Confluent Areas** to use proprietary algorithms with the provided drawing tools to graphically define the confluent areas and the background areas for the analysis.
- Click **Select Measurements** to view the results of the analysis for the wells you select.

Analysis Measurement Parameters

Depending on the needs of your application, you can use one or more of the following analysis measurement parameters for the region of interest (ROI) in your experiment:

- **Object Count:** The total number of objects detected in the image. Do not use for field analysis of confluent areas.
- **Field Count:** The total number of confluent areas detected in the image. Do not use for discrete object analysis.
- **Object Percentage:** The percentage the objects detected in the image by classification. Do not use for field analysis of confluent areas.
- **Covered Area:** The combined area of all the objects or confluent areas detected in the image as a percentage of the entire image area.
- **Object Area:** The average area of the objects detected in the image expressed in μm^2 . Do not use for field analysis of confluent areas.
- **Field Area:** The average area of the confluent areas detected in the image expressed in μm^2 . Do not use for discrete object analysis.
- **Object Roundness:** The average roundness of each object detected in the image. A shape factor of 1.00 is perfectly round, while a shape factor of 0.00 is not round at all. Do not use for field analysis of confluent areas.
- **Field Roundness:** The average roundness of each confluent area detected in the image. A shape factor of 1.00 is perfectly round, while a shape factor of 0.00 is not round at all. Do not use for discrete object analysis.
- **Object Average Intensity:** The average fluorescent signal intensity of the objects detected in the image. Do not use for field analysis of confluent areas or for transmitted light.
- **Field Average Intensity:** The average fluorescent signal intensity of the confluent areas detected in the image. This is not used for discrete object analysis or for transmitted light.
- **Object Intensity:** The average total fluorescent signal intensity of the objects detected in the image. Do not use for field analysis of confluent areas or for transmitted light.
- **Field Intensity:** The average total fluorescent signal intensity of the confluent areas in the image. Do not use for discrete object analysis or for transmitted light.
- **Total Intensity:** The combined total fluorescent signal intensity of the objects or confluent areas in the image expressed in million intensity counts. Do not use for transmitted light.

Luminescence Read Mode

Luminescence is the emission of light by processes that derive energy from essentially non-thermal changes, the motion of subatomic particles, or the excitation of an atomic system by radiation. Luminescence detection relies on the production of light from a chemical reaction in a sample.

In luminescence (LUM) read mode, no excitation is necessary as the measured species emit light naturally. For this reason, the lamp does not flash, so no background excitation interference occurs.

For the luminescence read mode, the instrument provides measurements in Relative Light Units (RLUs).

To help eliminate background luminescence from a plate that has been exposed to light, you should dark adapt the plate by placing the sample-loaded plate inside the instrument for several minutes before you start the read.

The instrument bypasses the emission monochromator for luminescence reads that detect all wavelengths.

You can choose the wavelength where peak emission is expected to occur. Also, multiple wavelength choices let species with multiple components be differentiated and measured easily.

When maximum sensitivity is required, Molecular Devices recommends the use of dual-color luminescence detection cartridges. See [Luminescence Detection Cartridges on page 64](#).

Concentrations or qualitative results are derived from raw data with a standard curve or by comparison with reference controls.

Applications of Luminescence

Chemiluminescent or bioluminescent reactions can be induced to measure the quantity of a particular compound in a sample. Examples of luminescent assays include the following:

- Reporter gene assays (the measurement of luciferase gene expression)
- Quantitation of adenosine triphosphate (ATP) as an indication of cell counts with cell-proliferation, cytotoxicity, and biomass assays
- Enzyme measurements with luminescent substrates, such as immunoassays

The SpectraMax i3x supports user-installable detection cartridges to expand its read capabilities. A luminescence (LUM) detection cartridge contains its own independent optics and electrical components needed to do specific read modes for specific applications.

For the SpectraMax i3x and the SpectraMax Paradigm, see [Luminescence Detection Cartridges on page 64](#).

Luminescence Reads with Injectors

Injectors deliver a specified volume of a reagent to the wells of a plate. You generally use injectors when delivery of the reagent initiates a reaction that occurs rapidly and results in a luminescent or fluorescent signal that you must quickly detect.

Common inject-and-read assays include calcium flux assays.

When you install the SpectraMax Injector cartridge in the SpectraMax i3x, you can create a protocol to inject and read well by well to reduce signal loss.

Common inject-and-read assays include luciferase reporter assays.

The SpectraMax Injector cartridge is DLReady™ certified by Promega for the Dual-Luciferase Reporter (DLR™) assay system.



DLReady, DLR, and the DLReady logo are trademarks of Promega Corporation.

Analyzing Luminescence Data

The conversion rate of photons to counts is individual for each reader. Therefore, raw data from the same plate can seem significantly different from one instrument to the next. Also, the data format used by other manufacturers might not be counts per second and can be different by several orders of magnitude. It is important to know that the number of counts and the size of figures is not a benchmark of sensitivity.

Concentrations or qualitative results are derived from raw data with a standard curve or by comparison with reference controls. The raw data can then be expressed in equivalent concentration of a reference label. The raw data is normalized to counts per second by dividing the number of counts by the read time per well.

Background Correction

The light detected in a luminescent measurement generally has two components: specific light from the luminescent reaction and an approximately constant level of background light caused by various factors, including the plate material and impurities in the reagents. The background can be effectively measured using blank replicates. Blanks should include the luminescent substrate (chemical energy source) but not the luminescence agent (generally an enzymatic group which makes the substrate glow).

A blank well contains everything used with the sample wells except the label and sample-specific compounds. Do not use an empty well for a blank.

The blank sample reveals the offset underlying each data sample. This offset does not carry information on the label and is generally subtracted before data reduction is done.

For optimal results, you should run replicates for all blanks, controls, and samples. In this case, the blank value that will be subtracted is the average value of all blanks.

To help eliminate background luminescence from a plate that has been exposed to light, you should dark adapt the plate by placing the sample-loaded plate inside the instrument for several minutes before you start the read.

Detection Limit

The detection limit is the smallest sample concentration that can be detected reliably above the blank. Determining the detection limit requires taking a number of blank measurements and calculating an average value and standard deviation for the blanks. The detection threshold is defined as the average blank plus three standard deviations. If the average sample value measures above the threshold, the sample can be detected at a statistically significant level.

The detection limit can be described by the following equation:

$$\text{Det Limit} = \frac{3 \text{ StDev}_{\text{blank}}}{\left(\frac{\text{std-blank}}{\text{conc}_{\text{std}}} \right)}$$

where conc_{std} is the concentration of the standard, $\text{StDev}_{\text{Blank}}$ is the standard deviation of the blank replicates, and blank and std are average values of the replicates for the blank and standard wells.

Determining the detection limit requires multiple blanks to calculate their standard deviation.

Sample Volumes and Concentration of Reactants

The concentration of the luminescent agent impacts the quantity of light output in a luminescent reaction. Light is emitted as a result of a reaction between two or more compounds. Therefore, the quantity of light output is proportional to the quantity of the limiting reagent in the sample.

For example, in an ATP/luciferin-luciferase system, when total volume is held constant and ATP is the limiting reagent, the blanked light output is proportional to the concentration of ATP in the sample. Even if the reaction begins with a high concentration of ATP, as it gets used up it can become rate-limiting. In this case, the non-linearity is an effect of the assay and not caused by the microplate reader.

Data Optimization

Measurement noise is dependent on the read time per sample (time per plate or time per well). The detection limit improves when you increase the read time. It is important to enter the read time when you compare measurements.

All low-light-level detection devices have some measurement noise in common. To average out the measurement noise, optimization of the time per well involves accumulating as many counts as possible. Within some range, you can reduce noise (CVs, detection limit) by increasing the read time per well, as far as is acceptable from throughput and sample stability considerations.

Z' is the standard statistical parameter in the high-throughput screening community to measure the quality of a screening assay independent of test compounds. Use this as a measure of the signal separation between the positive controls and the negative controls in an assay.

Use the following formula to determine the value of Z' :

$$Z' = 1 - \frac{3(\text{SD}_{\text{c}+}) + 3(\text{SD}_{\text{c}-})}{|\text{Mean}_{\text{c}+} - \text{Mean}_{\text{c}-}|}$$

where **SD** is the standard deviation, **c+** is the positive control, and **c-** is the negative control.

A Z' value greater than or equal to 0.4 is the generally acceptable minimum for an assay. You can use higher values when results are more critical.

Z' is not linear and can be made unrealistically small by outliers that skew the standard deviations in either population. To improve the Z' value, increase the quantity of label in the sample, if acceptable for the assay, or increase the read time per well.

Time-Resolved Fluorescence Read Mode

To use this read mode, you must install an applicable detection cartridge in the instrument.

Time-Resolved Fluorescence is a measurement technique that depends on three characteristics that lead to better discrimination between the specific signal, proportional to the quantity of label, and the unspecific fluorescence resulting from background and compound interference:

- Pulsed excitation light sources
- Time-gated electronics faster than the fluorescence lifetime
- Labels with prolonged fluorescence lifetime

The time-gating electronics introduce a delay between the cutoff of each light pulse and the start of signal collection. During the delay, the unspecific fluorescence (caused by test compounds, assay reagents, and the plate) vanishes, while only a small portion of the specific fluorescence from the label is sacrificed. Enough of the specific signal remains during the decay period, with the added benefit of reduced background.

In Time-Resolved Fluorescence read mode, the instrument detects the extremely long emission half-lives of rare earth elements called lanthanides, such as europium (lifetime of about 700 μ s), samarium (lifetime of about 70 μ s), or terbium (lifetime of about 1000 μ s).

Applications of Time-Resolved Fluorescence

Time-Resolved Fluorescence is widely used in high throughput screening applications such as kinase assays, and is useful in some fluorescence immunoassays, such as DELFIA (dissociation-enhanced enzyme linked fluorescence immunoassay). TRF is also useful in some assay variants of TR-FRET (Time-Resolved Fluorescence Resonance Energy Transfer) in which the FRET acceptor label acts as a quencher only and does not emit fluorescence. The proximity between donor label and acceptor (quencher) is then quantified by the intensity decrease of the donor label.

DELFIA requires washing steps as in an ELISA, but the TR-FRET assay involving quenching is a homogeneous plate assay technique and requires only mixing and measuring—no wash steps are required. It can also be miniaturized, which makes it useful for high-throughput screening applications.

The Cisbio Bioassays HTRF (Homogeneous Time-Resolved Fluorescence) technology is a proprietary Time-Resolved Fluorescence technology that overcomes many of the drawbacks of standard Fluorescence Resonance Energy Transfer (FRET) techniques, such as the requirements to correct for autofluorescence and the fluorescent contributions of unbound fluorophores. See [HTRF Read Mode on page 130](#).

The SpectraMax i3x supports user-installable detection cartridges to expand its read capabilities. Each detection cartridge contains the light source, optics, and electrical components needed to do specific read modes.

See [Time Resolved Fluorescence Detection Cartridges on page 71](#).

Analyzing Time-Resolved Fluorescence Data

A time-resolved fluorescence (TRF) measurement includes a number of pulses. Each pulse consists of turning the light source on, then off (Excitation Time), pausing for a specified length of time (Measurement Delay), and measuring the fluorescence intensity of the sample for a specified length of time (Integration Time). The pulses are repeated several times, as specified in the protocol parameters.

Blank Correction

Although background is significantly lower than with fluorescence intensity measurements, you should use blanks or assay controls. A blank well contains everything used with the sample wells except the label and sample-specific compounds. Do not use an empty well for a blank.

The blank sample reveals the offset underlying each data sample. This offset does not carry information on the label and is generally subtracted before data reduction is done. For optimal results, you should run replicates for all blanks, controls, and samples. In this case, the blank value that will be subtracted is the average value of all blanks.

Data Normalization

TRF raw data changes in magnitude when the timing parameters are changed. However, TRF data are normalized for a number of 1000 pulses. This means that the sample raw data does not change when only the number of pulses is changed.

Data Optimization

There are two timing parameters you can optimize to adjust the performance of the measurement: time per well and integration time per cycle.

Measurement noise is dependent on the read time per sample (time per plate or time per well). The detection limit improves when you increase the read time. It is important to enter the read time when you compare measurements. For TRF, the read time per well increases with the selected number of pulses. The time between pulses and the intensity of each pulse can be different on various systems.

All low-light-level detection devices have some measurement noise in common. To average out the measurement noise, optimization of the time per well involves accumulating as many counts as possible. Within some range, you can reduce noise (CVs, detection limit) by increasing the read time per well, as far as is acceptable from throughput and sample stability considerations.

To further optimize measurement results, optimize the timing parameters. Use the following table and figure as guidelines for the timing parameters.

Time-Resolved Fluorescence Timing Parameters Example

Parameter	Value	Comment
Pulse length	0.100 ms	Period for excitation of sample, t_1 in the following figure. The suggested value for TRF detection cartridge.
Measurement delay	0.010 ms	Delay to ensure excitation pulse is no longer detectable, t_2 in the following figure. Suggested value for TRF detection cartridge.
Integration time per cycle (pulse)	0.890 ms	Period to accumulate signal, t_3 in the following figure. Suggested value for TUNE and MULTI detection cartridges.
Integration time per cycle (pulse)	1.890 ms	Period to accumulate signal, t_3 in the following figure. Suggested value for TRF detection cartridge.
Total cycle time		Total cycle time is t_4 in the following figure.

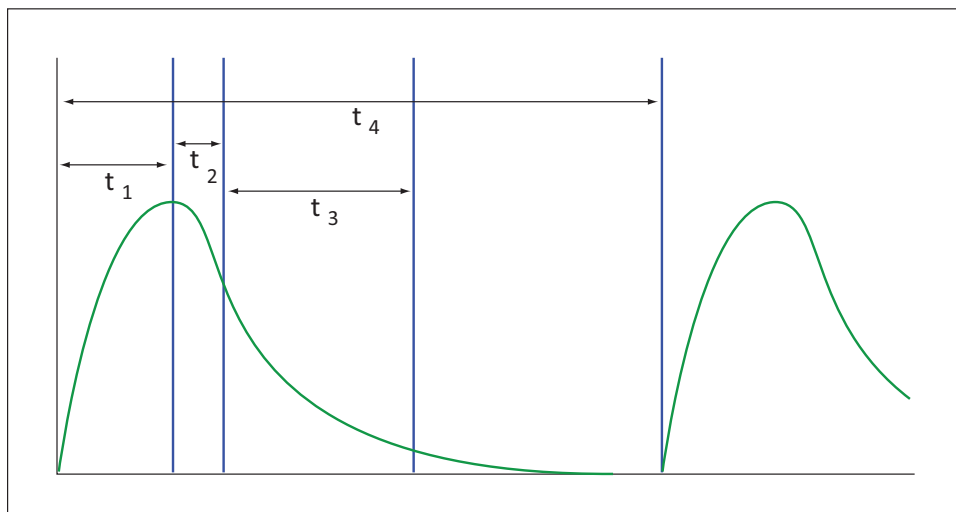

Timing Parameters For Time-Resolved Fluorescence

When you neglect the time delay t_2 compared to the integration time window t_3 , you can approximate the accumulated signal A with the following equation:

$$A / A_{\max} = (1 - \exp(-M)) \times 100\%$$

In this equation, M is the size of the time window (or integration time) divided by the exponential decay time constant (or the fluorescence lifetime of the label).

$$M = (\text{integration time}) / (\text{fluorescence lifetime})$$

For example, using Europium, which has a fluorescence lifetime of 700 μs , and the suggested integration time per cycle of 1.890 ms (or 1890 μs), $M = 1890 / 700 = 2.7$. Insert this value of M into the first equation to yield $A / A_{\max} = 93\%$.

To optimize the integration time per cycle (pulse), you should set the integration time such that the value of M produces the desired signal. For example, to get more than 86% signal, select an integration time such that M is greater than 2.0. Using the previous Europium example and solving for the integration time, you can set the integration time to $M(2.0)$ times the fluorescence lifetime (700 μs), or 1400 μs (1.4 ms).

Achievable Accumulated Signal Percentage Compared to M

M	0.25	0.50	0.75	1.00	1.25	1.50	2.00	3.00
A / A _{max} [%]	22	39	53	63	71	78	86	95

M can be technically limited by the time between pulses. Further gain in signal above some value of M can be negligible to improve results.

When you do a dual-label Europium-Samarium measurement, there are more timing parameters. There is some residual cross-talk of the Samarium signal captured in the Europium emission channel. Samarium has a much shorter fluorescence lifetime. To reduce the cross-talk of Samarium in the Europium channel, Europium is measured in a time window shifted away from the time window for Samarium. This lets the Europium be quantified without cross contamination from the Samarium. You can use the known Europium concentration to remove the Europium cross-contamination in the Samarium channel.

TRF Suggested Timing Parameters: Dual Label Europium-Samarium

Parameter	Value	Comment
Pulse length	0.100 ms	Time interval for flash monitoring. Suggested value for TRF detection cartridge.
Measurement delay (first window)	0.010 ms	Delay to ensure excitation pulse is no longer detectable. Suggested value for TRF detection cartridge.
Integration time (first window)	0.100 ms	Period to accumulate Samarium signal. Suggested value for TRF detection cartridge.
Measurement delay (second window)	0.140 ms	Read out of Samarium signal. Suggested value for TRF detection cartridge.
Integration time (second window)	0.750 ms	Period to accumulate Europium signal. Suggested value for TRF detection cartridge.

Western Blot Read Mode

To use this read mode, you must install an applicable detection cartridge in the instrument.

Western Blots (WB), or protein immunoblots, are one of the most common methods for protein detection in pharmaceutical and clinical research. You can use various techniques to detect proteins on Western Blot membranes including fluorescence, silver staining, and chemiluminescence. Each technique has its limitations. There is a continuous need to improve quantitation, accuracy, and dynamic range of Western Blots.

The Molecular Devices ScanLater™ Western Blot Assay Kit is a novel system for protein analysis. Membranes are incubated with Eu-chelate labeled secondary antibodies or streptavidin that bind specifically to the target protein-specific primary antibody. The Molecular Devices ScanLater™ Western Blot Assay Kit is a novel system for protein analysis that you can use with the SpectraMax i3x, SpectraMax iD5, and SpectraMax Paradigm. Membranes are incubated with Eu-chelate labeled secondary antibodies or streptavidin that bind specifically to the target protein-specific primary antibody. Europium has a long fluorescence lifetime, on the order of 1 msec, and detection is done in Time Resolved Fluorescence (TRF) mode which significantly reduces background from auto-fluorescence or other sources of short lifetime emissions. The membranes are placed into the instrument where the membranes are scanned with the ScanLater Western Blot (WB) detection cartridge (SpectraMax iD5 uses the Enhanced TRF module).

The method does not involve enzyme detection, and the Eu-chelates are resistant to photo-bleaching, so the signal remains stable for long periods of time (weeks to months). This allows you repeat the read of membranes and the potential for comparison of band intensities to known standards for more accurate quantitation. There is also no camera blooming, as can occur with chemiluminescence or fluorescence detection, so the system gives sharp bands and excellent image quality.

The TRF detection employs photon counting, so the theoretical dynamic range is $>10^5$. In practice, however, dynamic range is limited by saturation of binding sites on high-abundant bands and non-specific binding to background membrane.

Applications

- Identify the nature of the protein or epitope effectively. Also, it can be used as a tool for quantitative analysis of protein.
- Use for chromatography components analysis, sucrose gradient analysis.
- Test the endogenous or exogenous expression of phosphoprotein to detect the phosphorylation signal.
- Protein resilience in the function experiment.
- Structure domain analysis.
- Analysis of the protein expression level.
- Analysis of protein content in the serum.
- Analysis of regulatory proteins expressed in the cell cycle.

The following detection cartridge has Western Blot TRF read mode capability:

- [ScanLater Western Blot Detection Cartridge on page 68](#)

Analyzing Western Blot TRF Data

After you scan a membrane for Western Blot data, the data displays in the software as an image. Use the image tools in the Plate section to zoom, crop, colorize, and adjust the intensity of the image. You can select a region of interest (ROI) and rescan the membrane at a higher resolution.

Western Blot membrane data is saved as a TIFF image to allow you to use the image analysis tool of your choice for analysis. The SoftMax Pro Software includes a version of the ImageJ software from U.S. National Institute of Health (NIH).

For best results, use the Molecular Devices ScanLater™ Western Blot Assay Kit that matches your application.

Blocking Nonspecific Binding

To reduce noise, use blocking buffer to reduce non-specific protein from binding with the membrane.

No single-blocking reagent is optimal for every antigen-antibody pair. Some primary antibodies can exhibit greatly reduced signal or different nonspecific binding in different blocking solutions. If you have difficulty detecting your target protein, changing the blocking solution can dramatically improve the performance. If the primary antibody has worked well in the past using chemiluminescent detection, try that same blocking solution for detection. Other commonly used blocking buffers other than BSA are 3% casein and 5% non-fat milk.

Milk-based blockers can contain IgG that can cross react with anti-goat antibodies. This can significantly increase background and reduce antibody titer. Milk-based blockers can also contain endogenous biotin or phosphoepitopes that can cause higher background.

To prevent background speckles on blots, use high-quality, ultra-pure water for buffers.

Do not over-block. Extended blocking times can cause loss of target protein from the membrane.

Handling Membranes

You must place the membrane in a Molecular Devices ScanLater™ membrane holder to scan a membrane. See [Loading the Membrane Holder on page 68](#).



Note: Use clean forceps to handle membranes by their edges only. Do not touch the membrane with gloved or bare hands.

The maximum size of a membrane that fits in the membrane holder is 109 mm x 77 mm.

Use standard blotting procedures for the membrane to prepare for the Western Blot. For optimal results, use Millipore Immobilon FL (IPFL00010). If using PVDF, pre-wet the membrane in 100% methanol.

Use enough antibody volume so that the entire membrane surface is sufficiently covered with liquid at all times. Use heat-seal bags if the volume is limiting. Do not let an area of the membrane dry out. Use agitation for all antibody incubations.

Small proteins can pass through the membrane during transfer (“blow-through”). To prevent this, use a membrane with a smaller pore size or reduce the transfer time.

Allow the blot to dry for a minimum of 1 hour before detection.

Do not wrap the membrane in plastic for the scan.



Perform only the maintenance tasks described in this guide. Contact a Molecular Devices service engineer to inspect and perform a preventive maintenance service on the instrument each year. See [Obtaining Support on page 164](#).

Before operating the instrument or performing maintenance operations, make sure you are familiar with the safety information in this guide. See [Safety Information on page 5](#).



CAUTION! Maintenance procedures other than those specified in this guide must be performed by Molecular Devices. When service is required, contact Molecular Devices technical support.

Preventive Maintenance

To ensure optimal operation of the instrument, perform the following preventive maintenance procedures as needed:

- Wipe off visible dust from exterior surfaces with a lint-free cloth to avoid dust build-up on the instrument.
- Wipe up all spills immediately.
- Open the detection cartridge drawer only when installing or removing a detection cartridge.
- When a detection cartridge is not in use and removed from the instrument, always store the detection cartridge in the detection cartridge box.
- Follow applicable decontamination procedures as instructed by your laboratory safety officer.
- Contact Molecular Devices or an approved dealer for annual preventive maintenance. Molecular Devices recommends a yearly preventive maintenance be done on the instrument by a trained and qualified service engineer.
- Respond as required to all error messages displayed by the software.
- Power off the instrument when not in use.

Instrument Validation

Use an applicable Validation Plate to regularly test the functionality of the instrument and detection cartridges. For more details, contact sales or service.

Validation Packages Part Numbers

Part Number	Item Name	Compatible Instruments
n/a*	SpectraTest ABS1 Absorbance Validation Plate	FlexStation 3, SpectraMax 190, SpectraMax 340PC384, SpectraMax ABS, SpectraMax ABS Plus, SpectraMax i3, SpectraMax i3x, SpectraMax iD3, SpectraMax iD5, SpectraMax M2, SpectraMax M2e, SpectraMax M3, SpectraMax M4, SpectraMax M5, SpectraMax M5e, SpectraMax Plus 384, VersaMax
0200-6191	SpectraTest ABS2 Absorbance Validation Plate	FlexStation 3, SpectraMax ABS, SpectraMax ABS Plus, SpectraMax i3, SpectraMax i3x, SpectraMax iD3, SpectraMax iD5, SpectraMax M2, SpectraMax M2e, SpectraMax M3, SpectraMax M4, SpectraMax M5, SpectraMax M5e, SpectraMax Plus 384
0200-5060	SpectraTest FL1 Fluorescence Validation Plate	FlexStation 3, Gemini EM, Gemini XPS, SpectraMax i3, SpectraMax i3x, SpectraMax iD3, SpectraMax iD5, SpectraMax M2, SpectraMax M2e, SpectraMax M3, SpectraMax M4, SpectraMax M5, SpectraMax M5e
0200-6186	SpectraTest LM1 Luminescence Validation Plate	FlexStation 3, SpectraMax i3, SpectraMax i3x, SpectraMax iD3, SpectraMax iD5, SpectraMax L, SpectraMax M3, SpectraMax M4, SpectraMax M5, SpectraMax M5e
0200-2420	Cuvette Absorbance Validation Set	SpectraMax ABS Plus, SpectraMax M2, SpectraMax M2e, SpectraMax M3, SpectraMax M4, SpectraMax M5, SpectraMax M5e, SpectraMax Plus 384
0200-7200	Multi-Mode Validation Plate	FilterMax F3, FilterMax F5, SpectraMax i3*, SpectraMax i3x*, SpectraMax iD5*, SpectraMax Paradigm * Specific read modes or cartridges.

* Discontinued. Use the SpectraTest ABS2 Absorbance Validation Plate.

Cleaning the Instrument



WARNING! BIOHAZARD. It is your responsibility to decontaminate components of the instrument before you request service by a service engineer or you return parts to Molecular Devices for repair. Molecular Devices does not accept items that have not been decontaminated where applicable to do so. If parts are returned, they must be enclosed in a sealed plastic bag that states that the contents are safe to handle and are not contaminated.



WARNING! BIOHAZARD. Always wear gloves when operating the instrument and during cleaning procedures that could involve contact with either hazardous or biohazardous materials or fluids.



CAUTION! Do not use abrasive cleaners. Do not spray cleaner directly onto the instrument or into any openings. Do not let water or other fluids drip inside the instrument.

- Always turn the power switch off and disconnect the power cord from the main power source before using liquids to clean the instrument.
- Wipe up spills immediately.
- Periodically clean the outside surfaces of the instrument using a cloth or sponge that has been lightly dampened with water.
- If required, clean the surfaces using a mild soap solution diluted with water or a glass cleaner and then wipe with a damp cloth or sponge to remove all residue.
- If needed, clean the plate drawer using a cloth or sponge that has been lightly dampened with water.
- If a bleach solution has been used, wipe the instrument using a lint-free cloth that has been lightly dampened with water to remove the bleach residue.

Replacing Fuses

If the instrument does not seem to be getting power after switching it on, check to see whether the supplied power cord is securely plugged into a functioning power outlet and to the power port on the rear of the instrument.

If the power failed while the instrument was on, check that the power cord is not loose or disconnected and that power to the power outlet is functioning properly.

If these checks fail to remedy the loss of power, replace the fuses. You can obtain replacement fuses from Molecular Devices. For fuse specifications and part numbers, see [Physical Specifications on page 169](#).



CAUTION! Do not touch or loosen screws or parts other than those specifically designated in the instructions. Doing so could cause misalignment and possibly void the warranty.

The fuses are located in the fuse carrier on the rear of the instrument.

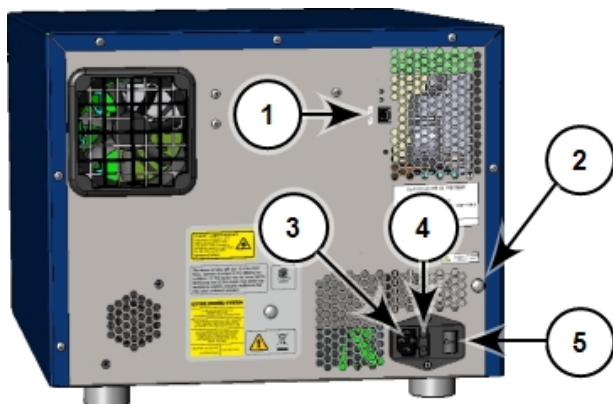

Item	Description
1	USB port
2	Gas inlet quick connect fitting
3	Power port
4	Fuse carrier
5	Power switch

To replace the fuses:



WARNING! HIGH VOLTAGE Power off the instrument and disconnect the power cord before you do maintenance procedures that require removal of a panel or cover or disassembly of an interior instrument component.

1. Power off the instrument.
2. Unplug the power cord from the power port.
3. Use a small flat head screwdriver to gently press on the carrier release tab and then pull the fuse carrier to remove it from the instrument.

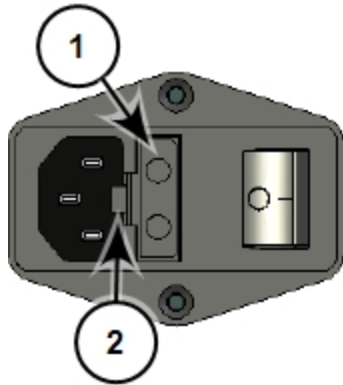

Release Fuse Carrier

Item	Description
1	Fuse carrier
2	Carrier release tab

4. Gently pull the old fuses from the carrier by hand.
5. Place new fuses into the carrier by hand.
6. Press the fuse carrier into the instrument until the carrier snaps into place.
7. Plug the power cord into the power port.
8. Power on the instrument.



Note: If the instrument still does not power on after you change the fuses, contact Molecular Devices technical support. See [Obtaining Support on page 164](#).

Before You Move the Instrument



WARNING! LIFTING HAZARD. To prevent injury, use a minimum of two people to lift the instrument.

Before you move the SpectraMax i3x, make sure that the new location is a dry, flat work area that has sufficient space for the instrument, host computer, and required cables. See [Instrument Specifications on page 165](#).



CAUTION! When transporting the instrument, warranty claims are void if improper packing results in damage to the instrument.

To move the instrument:

1. Disconnect the gas supply line, if applicable. See [Connecting Gas Supply on page 24](#).
2. Install the transport locks on the plate drawer and the detection cartridge drawer. See [Installing Transport Locks on page 157](#).
3. If you need to prepare the instrument for shipment, remove the cytometer. See [Preparing the Cytometer for Shipment on page 151](#).
4. Pack the microplate reader in the original packaging. See [Packing the Microplate Reader on page 161](#).

Preparing the Cytometer for Shipment

To minimize the possibility of damage during storage or shipment, you should pack the cytometer in the original packaging materials. Correctly repacking the instrument includes following applicable decontamination procedures and replacing the wing nut, the retaining screws, and the optics-access cover that protect the optical components during shipping.



CAUTION! When transporting the instrument, warranty claims are void if improper packing results in damage to the instrument.

Store the cytometer in a dry, dust-free, environmentally controlled area.

Disconnecting the Cytometer Cables

The power cords and USB cables connect to the ports on the rear of the instrument.

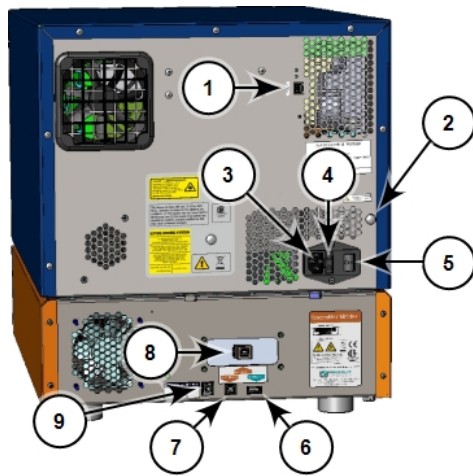

Item	Description
1	Microplate reader USB port
2	Gas inlet quick-connect fitting
3	Power port
4	Fuse carrier
5	Power switch
6	Interconnect USB port
7	Cytometer USB port 1
8	Cytometer USB port 2
9	Alternative power input for the SpectraMax i3 Multi-Mode Platform.

To disconnect the cytometer cables:

1. Close the SoftMax Pro Software.
2. Power off the computer.
3. Power off the instrument.
4. Unplug the power cord from the power port on the rear of the microplate reader and from the wall outlet.
5. If applicable, unplug the alternative power supply cord from the alternative power supply port on the rear of the cytometer and from the wall outlet.
6. Disconnect the USB cable from the USB port labeled COMPUTER USB 2 on the rear of the cytometer and from the computer.
7. Disconnect the USB cable from the USB port labeled COMPUTER USB 1 on the rear of the cytometer and from the computer.
8. Disconnect the short USB cable from the interconnect USB port labeled SpectraMax System (6) on the rear of the cytometer and from the microplate reader.
9. Store all cables and the external power supply (if equipped) in the cytometer shipping container.

Removing the Cytometer from the Microplate Reader

Removal of the cytometer from the microplate reader requires a work area that is approximately 130 cm (51.2 in.) wide and 65 cm (25.6 in.) deep, preferably with access on all sides for lifting the instruments.

The required vertical clearance for this procedure is 56 cm (22.0 in.).



WARNING! LIFTING HAZARD. To prevent injury, use a minimum of two people to lift the instrument.

Required Accessories

Part Number	Item
Not applicable	Foam pad from the shipping container
5024094	2.5 mm hex key
17-100-0010	Flat head screwdriver
MK 113 700	Optics access foam block
MG 115 500	Optics access cover

To remove the cytometer from the microplate reader:

1. Place a foam pad from the shipping container on the work bench on one side of the instrument.
2. Use two people to carefully place the instrument on its side on top of the foam pad.
3. Use a flat head screwdriver to loosen the four bolts on the bottom of the cytometer.

- Slide the cytometer away from the microplate reader, being careful not to strike or otherwise damage the optics tower.

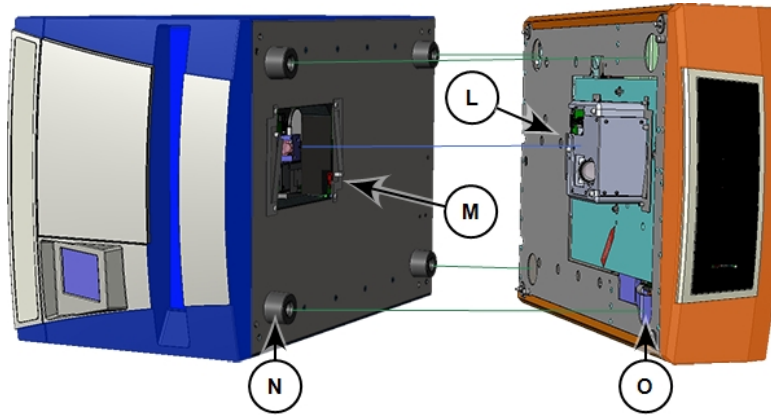

Detach the Cytometer From the Microplate Reader

Item	Description
L	Optics tower
M	Optics access opening
N	Microplate reader feet
O	Microplate reader foot openings

- Carefully stand the cytometer upright.
- Use the 2.5 mm hex key to remove the four screws that secure the laser interlock brackets to the bottom of the microplate reader.

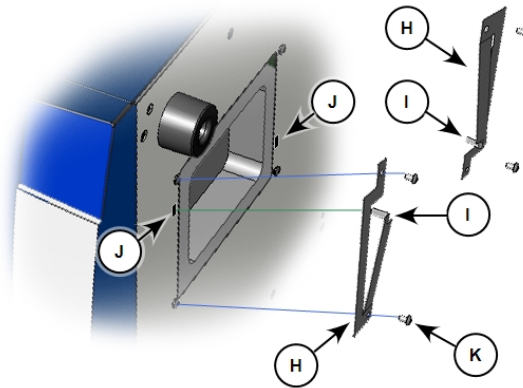

Optics Access Opening Bracket

Item	Description
H	2 Laser interlock brackets
I	2 Interlock tabs
J	2 Alignment slots
K	4 Screws

7. Remove the laser interlock brackets from the microplate reader and set the brackets and screws aside.
8. Insert the foam block into the optics access opening.
9. Place the optics access cover over the optics access opening with the alignment tabs on the cover inserted into the alignment slots on the bottom of the microplate reader.

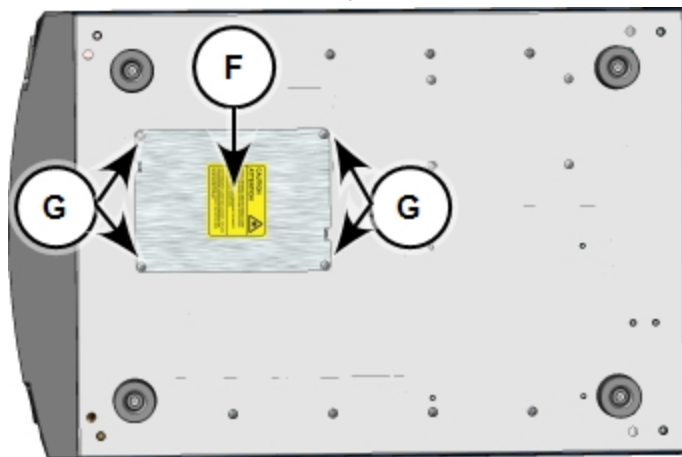

Microplate Reader Bottom

Item	Description
F	Optics access cover
G	4 Screws

10. Use the 2.5 mm hex key and the four original screws to secure the optics access cover to the bottom of the microplate reader.
11. Use two people to carefully stand the microplate reader upright.
12. Store the tools and laser interlock brackets in the cytometer shipping container.



WARNING! LASER LIGHT. The optics access cover on the bottom of the SpectraMax i3x has a hardware interlock that prevents the laser module from turning on, unless the cover is in place. The installed cover closes the protective housing.

Attaching Shipment Protections and Packing the Instrument

To prevent damage during shipping, four wing nuts secure the bolts in the corners, a transport bracket with six blue retaining screws and three more blue retaining screws secure the optics plate on the top of the cytometer, and a cover with three blue retaining screws protects the optical components in the optics tower.

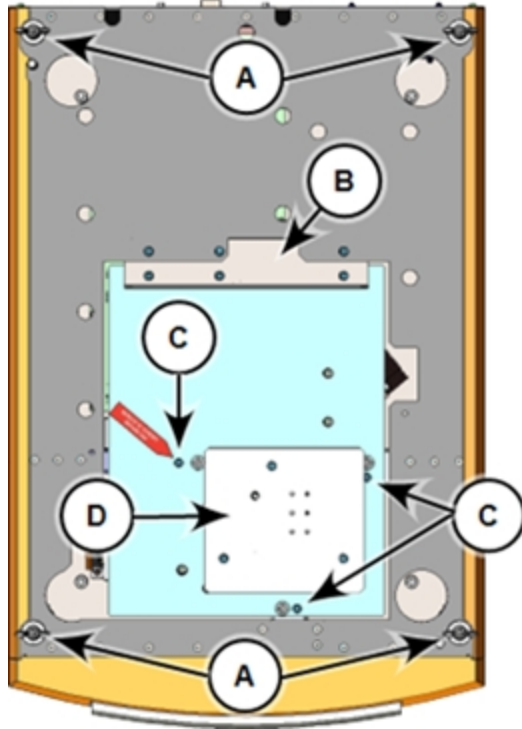

Optics Protection for Shipment	Description
A	4 Wing nuts and bolts
B	6 Transport bracket and retaining screws
C	3 Optics plate retaining screws
D	3 Optics cover and retaining screws

CAUTION! Never touch the optic mirrors, lenses, filters, or cables. The optics are extremely delicate, and critical to the function of the instrument.

Required Tool

Part Number	Item
5025258	3.0 mm hex key

To attach the shipping protections to the cytometer:

1. Carefully place the protective cover (D) onto the optics tower (L) with the foam resting on top of the lenses.

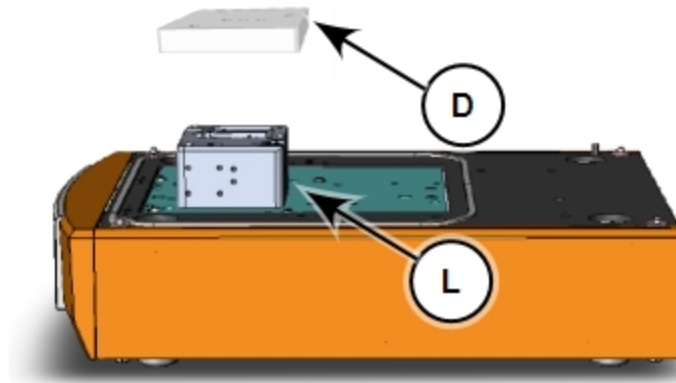

Place Optics Cover

Item	Description
D	Optics cover
L	Optics tower

2. Use the 3.0 mm hex key to tighten three of the blue retaining screws into their transport locations (E) to secure the cover to the optics tower.

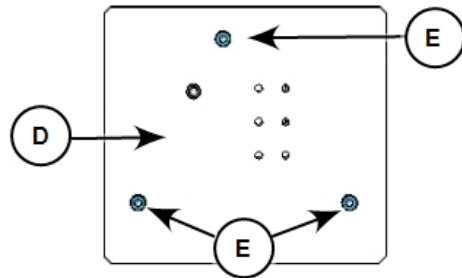

Optics Cover (top view)	Description
D	Optics cover
E	3 Optics cover retaining screws

3. Insert three of the blue retaining screws in their transport locations (B) in the optics plate, and then use the 3.0 mm hex key to tighten the screws to secure the optics plate. You might need to press down the optics plate as you tighten the screws.
4. Position the transport bracket (B) and then use the 3.0 mm hex key to tighten the remaining six blue retaining screws to secure the further optics plate for shipping.
5. Hand-tighten the four wing nuts (A) on the bolts in the corners of the cytometer.
6. Use the original plastic bag and foam padding to repackage the cytometer and accessories in the cytometer shipping container.

Preparing the Microplate Reader for Shipment

To minimize the possibility of damage during storage or shipment, the instrument should be repacked in the original packaging materials. Correctly repacking the instrument includes following applicable decontamination procedures and installing the transport locks on the plate drawer and detection cartridge drawers.



CAUTION! When transporting the instrument, warranty claims are void if improper packing results in damage to the instrument.

Store the instrument in a dry, dust-free, environmentally controlled area.

Installing Transport Locks

Before you move or pack the SpectraMax i3x, install the transport locks on the plate drawer and the detection cartridge drawer to protect the instrument from damage during shipping.

Required Tool

Part Number	Description
YW 000 006	2.0 mm hex key



CAUTION! Do not touch or loosen screws or parts other than those specifically designated in the instructions. Doing so could cause misalignment and possibly void the warranty.



CAUTION! The front cover is held onto the front of the instrument by powerful magnets. Keep magnetic storage devices or strips, such as hard drives, key cards, and credit cards, away from the instrument covers.

To install the transport locks:

1. Turn on the power switch on the rear of the instrument.
2. Remove all detection cartridges from the detection cartridge drawer. See [Removing Detection Cartridges on page 52](#).
3. Close the detection cartridge drawer.
4. Remove the plate from the plate drawer. See [Loading and Unloading Plates on page 45](#).
5. Leave the plate drawer open.
6. Switch the power switch on the rear of the instrument to the off position.
7. Unplug the power cord from the power port on the rear of the instrument.
8. Place the plate drawer transport lock on the end of the plate drawer.

9. Use the 2.0 mm hex key to tighten screws #2 and #3 until the lock is attached to the plate drawer.

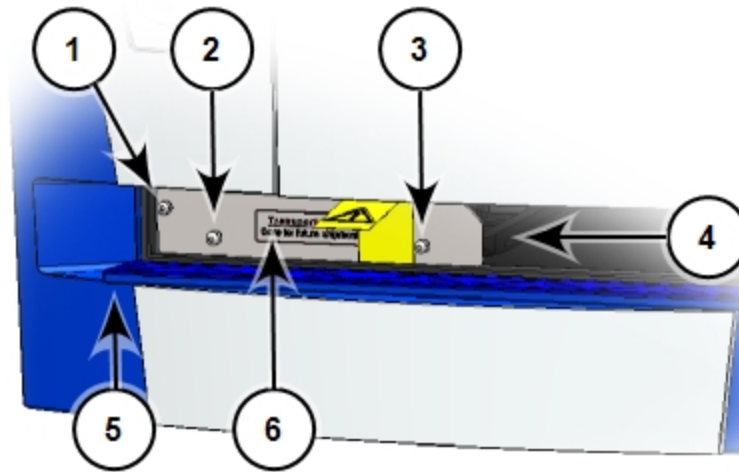

Item	Description
1	Screw #1 fastens the lock to the internal frame of the instrument
2	Screw #2 fastens the lock to the plate drawer
3	Screw #3 fastens the lock to the plate drawer
4	Plate drawer
5	Plate chamber door in open position
6	Plate drawer transport lock

10. Gently push the plate drawer into the instrument and as far to the left as possible until screw #1, which fastens the lock to the internal frame of the instrument, is lined up with the hole on the internal frame. The plate chamber door must be held open manually until the transport lock is fastened.
11. Tighten screw #1 until the plate drawer is securely locked in place.
12. Route the yellow tab connected to the transport lock so that it will pass over the top of the plate chamber door when closed.
13. Close the plate chamber door.
14. Firmly pull on the front cover to remove it and then set it aside. The front cover is held onto the front of the instrument by magnets.

*** Tip:** It is easiest to remove the front cover by pulling from the bottom.

15. Slide the detection cartridge drawer forward until it is outside the main instrument.

- Place the tab on the detection cartridge drawer transport lock into the slot on the bottom of the detection cartridge drawer.

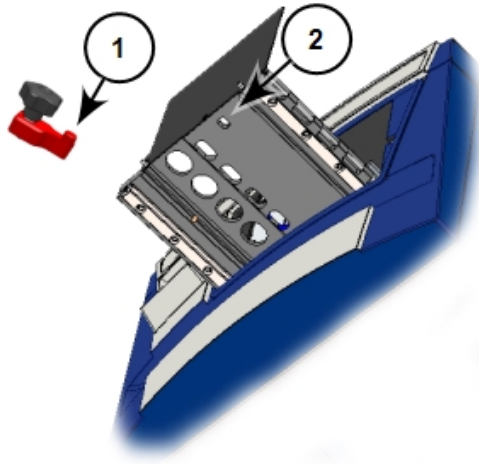

Detection Cartridge Drawer (bottom view)

Item	Description
1	Detection cartridge drawer transport lock tab
2	Detection cartridge drawer transport lock slot

- Push the detection cartridge drawer back inside the instrument.



Item	Description
1	Detection cartridge drawer
2	Detection cartridge drawer transport lock

- Align the detection cartridge transport lock with the threaded hole on the floor of the detection cartridge drawer chamber, and then turn the transport lock clockwise to lock the detection cartridge drawer in place.
- Replace the front cover by aligning the magnets on the inside of the front cover with the magnets on the instrument base.

Disconnecting Instrument Cables

Before you disconnect the cables, make sure you have done all the steps to install the transport locks.



Note: If you disconnect the SpectraMax MiniMax 300 Imaging Cytometer, do not use this procedure. See [Preparing the Cytometer for Shipment on page 151](#).

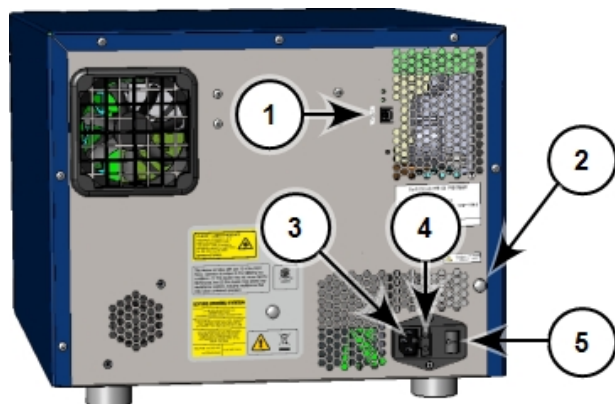

Item	Description
1	USB port
2	Gas inlet quick connect fitting
3	Power port
4	Fuse carrier
5	Power switch

To disconnect the instrument cables:

1. Disconnect the gas supply line, if applicable.
2. Unplug the power cord from the instrument and from the wall outlet.
3. Disconnect the USB cable from the instrument and from the computer.
4. Store the power cord and the USB cable in the accessories tool box.

Packing the Microplate Reader

The original packaging is specifically designed to protect the instrument during transportation. You must pack and ship detection cartridges separately from the instrument.



WARNING! LIFTING HAZARD. To prevent injury, use a minimum of two people to lift the instrument.



CAUTION! When transporting the instrument, warranty claims are void if improper packing results in damage to the instrument.

To pack the instrument:

1. Make sure that all detection cartridges and plates are removed and the transport locks are installed. See [Installing Transport Locks on page 157](#).
2. Turn off the SoftMax Pro Software and power off the computer.
3. Make sure that the power switch on the rear of the instrument is in the off position and that the power cord and USB cables are disconnected. See [Disconnecting Instrument Cables on page 160](#).
4. Store the power cord and the USB cable in the instrument accessories tool box.
5. If applicable, make sure the gas supply line is disconnected. See [Connecting Gas Supply on page 24](#).
6. If applicable, make sure the SpectraMax MiniMax 300 Imaging Cytometer has been removed and stored. See [Preparing the Cytometer for Shipment on page 151](#).
7. Wrap the SpectraMax i3x in static-free plastic.
8. Replace the two pieces of molded foam packaging on each end of the instrument.

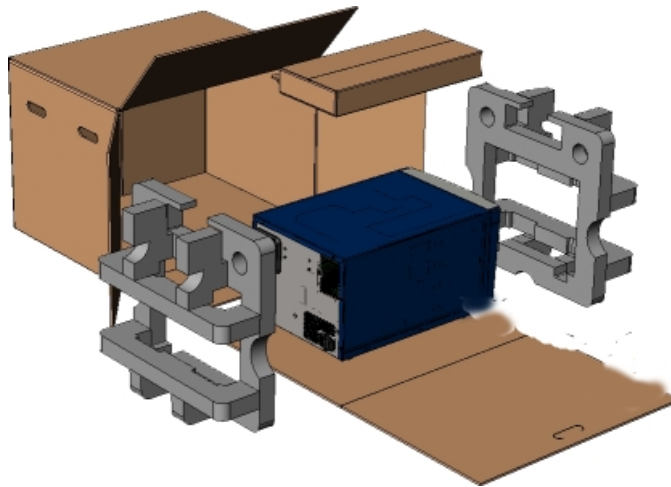

Item	Description
1	Accessories Tool Box
2	SpectraMax i3x



CAUTION! Keep the instrument upright and level when lifting. Do not tip or shake the instrument to prevent damage to the moving components inside the instrument.

9. Place the accessories tool box in the foam packaging above the instrument.

10. Place the instrument and accessories tool box on the flat cardboard piece and slide it into the original box.

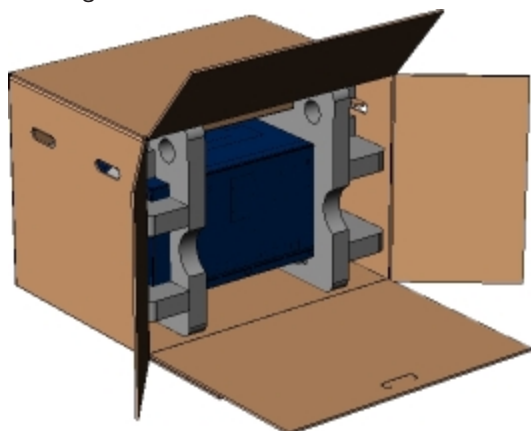

11. Fold the cardboard flap up inside the box.



12. Along the side labeled Open Here, close the box and seal it with packing tape.



Troubleshooting



CAUTION! Maintenance procedures other than those specified in this guide must be performed by Molecular Devices. When service is required, contact Molecular Devices technical support.

If	Then
The touchscreen does not illuminate.	Make sure that the instrument is plugged in and powered on. Inspect the fuses. See Replacing Fuses on page 148 .
The fuses look burned or the filaments are broken.	Replace the fuses. See Replacing Fuses on page 148 .
The touchscreen does not illuminate, the power is on, the fuses are okay, and the instrument does not operate.	Contact technical support. See Obtaining Support on page 164 .
The instrument does not respond to commands from the software.	Observe the status indicators and respond as required. See Status Indicators on page 44 . Inspect the USB connections to the instrument and the controlling computer. When the computer and instrument are both on and connected, a green LED illuminates above the USB port on the instrument. In the software, verify that the configured USB port matches the USB port connecting the instrument to the computer. See “Selecting an Instrument” in the <i>SoftMax Pro Data Acquisition and Analysis Software User Guide</i> or the application help. Contact technical support. See Obtaining Support on page 164 .
Functional failure of a detection cartridge	Contact technical support. See Obtaining Support on page 164 .

For more information about the status indicators, see [Status Indicators on page 44](#).

Obtaining Support

Molecular Devices is a leading worldwide manufacturer and distributor of analytical instrumentation, software, and reagents. We are committed to the quality of our products and to fully supporting our customers with the highest level of technical service.

Our Support website, support.moleculardevices.com, has a link to the Knowledge Base, which contains technical notes, software upgrades, safety data sheets, and other resources. If you still need assistance after consulting the Knowledge Base, you can submit a request to Molecular Devices Technical Support.

You can contact your local representative or Molecular Devices Technical Support at 800-635-5577 x 1815 (North America only) or +1 408-747-1700.

In Europe call +44 (0) 118 944 8000.

To find regional support contact information, visit www.moleculardevices.com/contact.

Please have your instrument serial number or Work Order number, and your software version number available when you call.



WARNING! BIOHAZARD. It is your responsibility to decontaminate components of the instrument before you request service by a service engineer or you return parts to Molecular Devices for repair. Molecular Devices does not accept items that have not been decontaminated where it is applicable to do so. If parts are returned, they must be enclosed in a sealed plastic bag stating that the contents are safe to handle and are not contaminated.

Appendix A: Instrument Specifications



This appendix provides specifications for the SpectraMax i3x basic unit and the SpectraMax MiniMax 300 Imaging Cytometer.

The specifications for each of the optional detection cartridges are in the section that describes the specific cartridge. See [Detection Cartridges on page 53](#).

Measurement Specifications

The following tables list the measurement specifications of the SpectraMax i3x.

Table A-1: Absorbance Measurement Specifications of the SpectraMax i3x

Item	Description
Wavelength range	230 nm to 1000 nm
Wavelength selection	Monochromator tunable in 1 nm increments
Wavelength bandwidth	~4.0 nm full width half maximum
Wavelength accuracy	±2.0 nm across wavelength range
Wavelength repeatability	±1.0 nm
Photometric range	0.000 to 4.000 OD
Photometric resolution	0.001 OD
Photometric accuracy/linearity	< ±0.010 OD ±1.0%, 0 - 3 OD VIS 0 - 2 OD UV
Photometric precision (repeatability)	< ±0.003 OD ±1.0%, 0 - 3 OD VIS 0 - 2 OD UV
Stray light	≤ 0.05% at 230 nm
Photometric stabilization	Instantaneous
Photometric drift	None (continuous referencing of monochromatic input)
Calibration	Automatic before every endpoint read and before the first kinetic read
Optical alignment	None required
Light source	High power Xenon flash lamp
Average lamp lifetime	1 billion flashes or 2 years normal operation (approx. 500,000 96-well plates at normal speed or 400,000 384-well plates at speed read)
Photodetectors	Silicon photodiode

Table A-2: Fluorescence Intensity Measurement Specification of the SpectraMax i3x

Item	Description
Sensitivity (top read) For properly functioning, operating, and maintained equipment	96-well Guaranteed: 2 pM fluorescein Optimized: 0.5 pM fluorescein 384-well Guaranteed: 4 pM fluorescein Optimized: 1 pM fluorescein
Sensitivity (bottom read) For properly functioning, operating, and maintained equipment	96-well Guaranteed: 10 pM fluorescein Optimized: 2.5 pM fluorescein 384-well Guaranteed: 20 pM fluorescein Optimized: 5 pM fluorescein
Wavelength range	EX: 250 nm to 830 nm EM: 270 nm to 850 nm
Wavelength accuracy	±2 nm
Wavelength precision	±1 nm
Wavelength selection	Monochromators tunable in 1.0 nm increments
Bandwidth	EX: 9 nm or 15 nm EM: 15 nm or 25 nm
Number of excitation/emission pairs per plate	4
Dynamic range	>10 ⁶ in 96-well black plates: auto gain circuitry
System validation	Self calibrating with built-in fluorescence calibrators
Light source	High power Xenon flash lamp; LEDs in the visible range
Average lamp lifetime	1 billion flashes or 2 years normal operation (Based on specifications from the manufacturer. Individual average lamp lifetime can vary.)
Detector	Photomultiplier tube

Table A-3: Luminescence Measurement Specifications of the SpectraMax i3x

Item	Description
Sensitivity (top read) For properly functioning, operating, and maintained equipment	96-well Guaranteed: 15 pM ATP-Glow Optimized: 3 pM ATP-Glow 384-well Guaranteed: 30 pM ATP-Glow Optimized: 6 pM ATP-Glow
Wavelength range	300 nm to 850 nm
Wavelength accuracy	±2 nm
Wavelength precision	±1 nm
Dynamic range	>6 decades
Crosstalk	<0.4% in white 96-well <0.4% in white 384-well

Cytometer Measurement Specifications

The following tables list the measurement specifications of the SpectraMax MiniMax 300 Imaging Cytometer and the Transmitted Light (TL) detection cartridge.

Table A-4: Measurement Specification for SpectraMax MiniMax 300 Imaging Cytometer

Item	Description
Light source	Proprietary, solid-state illumination
Wavelength range	EX: White, EM: Brightfield EX: 456/20 nm, EM: 541/108 nm EX: 625/20 nm, EM: 713/123 nm
Detector	1.25 megapixel, 12-bit, high-sensitivity CCD camera
Objective	Single 4X objective
Resolution	1.875 μm x 1.875 μm pixel size
Autofocus	Proprietary laser-scanning autofocus
Plate formats	96-well and 384-well, flat-bottomed, clear-bottomed plates, ANSI/SBS conformant Maximum height: 25 mm

Table A-5: Measurement Specification for Transmitted Light (TL) detection cartridge

Item	Description
Detection cartridge name	Transmitted Light (TL) detection cartridge
Short name	TL
Part number	5022671
Weight	1.5 lbs (0.7 kg)
Read modes	Imaging
Type	Transmitted light
Number of slots	1
Light source	Ultra-high power LED
Wavelength range	White light, brightfield

Physical Specifications

The following tables list the physical specifications of the SpectraMax i3x and the SpectraMax MiniMax 300 Imaging Cytometer.

Table A-6: Physical Specifications of the SpectraMax i3x

Item	Description
Environment	Indoor use only
Power requirements SpectraMax i3x alone	100 VAC to 240 VAC $\pm 10\%$, 2 amps, frequency range: 50/60 Hz
Power requirements SpectraMax i3x and SpectraMax MiniMax 300 Imaging Cytometer together	100 VAC to 240 VAC $\pm 10\%$, frequency range: 50/60 Hz, Max. 350 VA
Dimensions SpectraMax i3x alone	39.20 cm W x 32.50 cm H x 60.55 cm D (15.43 in. W x 12.80 in. H x 23.84 in. D)
Dimensions SpectraMax MiniMax 300 Imaging Cytometer alone	39.20 cm W x 20.24 cm H x 60.55 cm D (15.43 in. W x 7.97 in. H x 23.84 in. D)
Dimensions SpectraMax i3x and SpectraMax MiniMax 300 Imaging Cytometer together	39.20 cm W x 44.59 cm H x 60.55 cm D (15.43 in. W x 17.56 in. H x 23.84 in. D)
Weight SpectraMax i3x alone	Without detection cartridges: 31 kg (68.3 lbs) For detection cartridge weights, see the detection cartridge chapters.
Weight SpectraMax MiniMax 300 Imaging Cytometer alone	17.7 kg (39 lbs)
Weight SpectraMax i3x and SpectraMax MiniMax 300 Imaging Cytometer together	48.7 kg (107.3 lbs)
Power disconnect and ventilation clearance (rear)	20 cm to 30 cm (7.9 in. to 11.8 in.) between the rear of the instrument and the wall
Drawer clearance (front)	18 cm (7.1 in.) for the plate drawer and 15 cm (5.9 in.) for the detection cartridge drawer
Ambient operating temperature	15°C to 40°C (59°F to 104°F)
Ambient storage temperature	-5°C to 40°C (23°F to 104°F) continuous; -20°C to 50°C (-4°F to 122°F) transient (up to 10 hours)
Humidity restrictions	15% to 75% (non-condensing) at 30°C (86°F)
Altitude restrictions	Up to 2000 m (6562 ft)
Air pressure restrictions	54 kPa to 106 kPa (7.8 PSI to 15.4 PSI)

Table A-6: Physical Specifications of the SpectraMax i3x (continued)

Item	Description
Sound pressure level	Maximum sound pressure: 73 dBA Maximum sound pressure at one meter: 68 dBA
Installation category	II
Pollution degree	2
Fuses	250 V, 4 amp, 5 x 20 mm, slow-blow, UL recognized/CSA/VDE (part number: S US 400 153)
Data connection SpectraMax i3x alone	One (1) USB port
Data connection SpectraMax i3x and SpectraMax MiniMax 300 Imaging Cytometer together	Three (3) USB ports
Plate formats	6, 12, 24, 48, 96, 384, and 1536-well plates, ANSI/SLAS conformant Maximum height: 25 mm

Table A-7: Environmental Controls of the SpectraMax i3x

Item	Description
Temperature range	4°C (7.2°F) above ambient to 45°C (113°F)
Displayed	1°C (1.8°F) increments
Accuracy	±1°C (1.8°F) at 37°C (98.6°F) set point
Uniformity	±0.75°C (1.4°F)
Gas inlet specification	Maximum air supply pressure: 0.4 MPa (58 psi)
Gas tubing specification	Polyurethane tubing, outside diameter = 4.0 mm



WARNING! Use a compressed gas supply in a well-ventilated area. The instrument is not air-tight. Gas can escape into the atmosphere surrounding the instrument. When you use potentially toxic gas, observe the cautionary procedures your safety officer defines to maintain a safe work environment.

Appendix B: System Diagrams and Dimensions



In the following drawings, the dimensions are show in centimeters and inches.

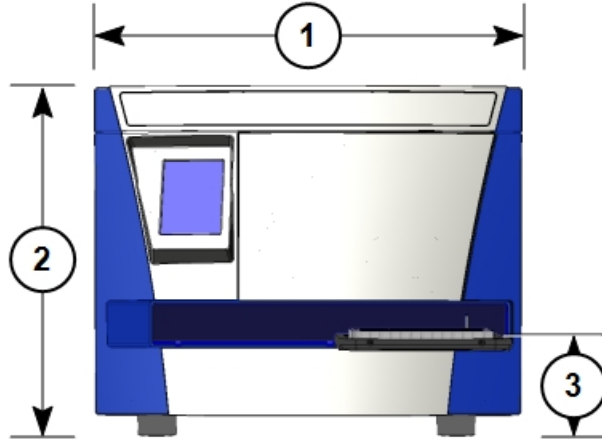

Figure B-1: Front View: SpectraMax i3x with Dimensions

Item	Description
1	Width: 39.20 cm (15.43 in.)
2	Height: 32.50 cm (12.80 in.)
3	Height of Plate Drawer: 9.5 cm (3.7 in.)

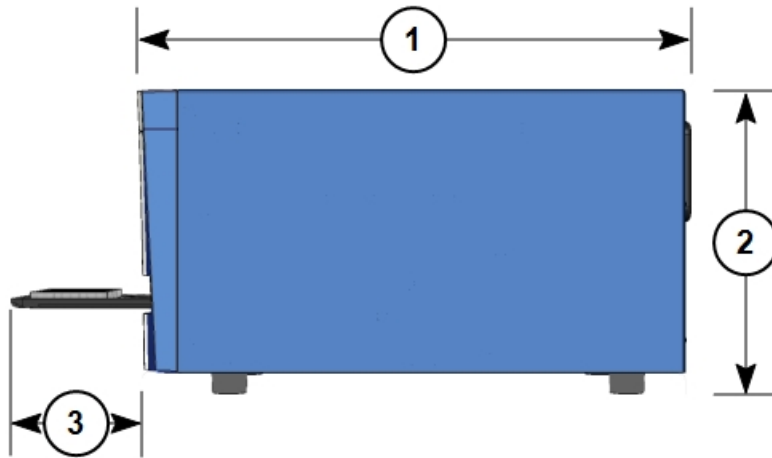

Figure B-2: Side View: SpectraMax i3x with Dimensions

Item	Description
1	Depth: 60.55 cm (23.84 in.)
2	Height: 32.50 cm (12.80 in.)
3	Maximum Length of Opened Plate Drawer: 17.5 cm (6.8 in.)

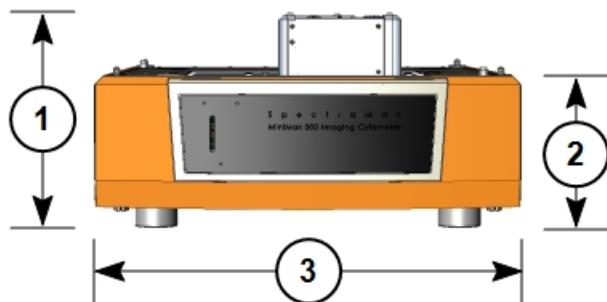

Figure B-3: Front View: SpectraMax MiniMax 300 Imaging Cytometer with Dimensions

Item	Description
1	Full Height: 20.24 cm (7.97 in.)
2	Height of Housing: 14.59 cm (5.74 in.)
3	Width: 39.20 cm (15.43 in.)

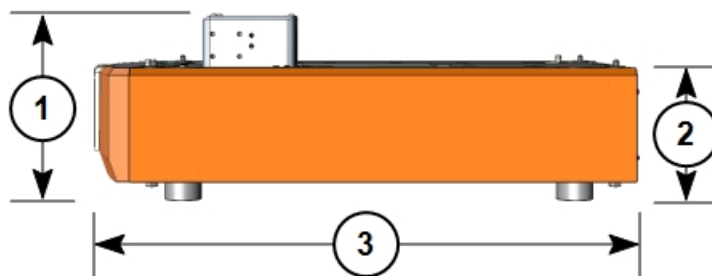

Figure B-4: Side View: SpectraMax MiniMax 300 Imaging Cytometer with Dimensions

Item	Description
1	Full Height: 20.24 cm (7.97 in.)
2	Height of Housing: 14.59 cm (5.74 in.)
3	Depth: 60.55 cm (23.84 in.)

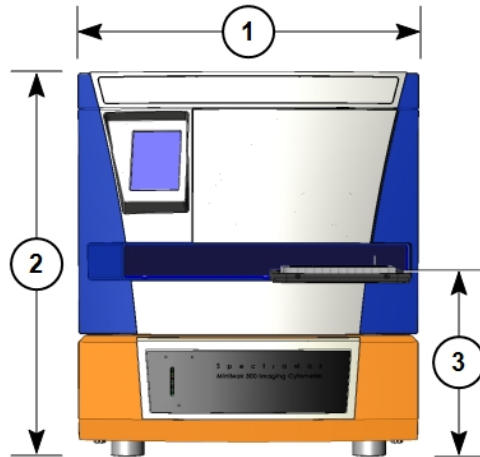

Figure B-5: Front View: SpectraMax i3x with Dimensions

Item	Description
1	Width: 39.20 cm (15.43 in.)
2	Height: 44.59 cm (17.56 in.)
3	Height of Plate Drawer: 22 cm (8.6 in.)

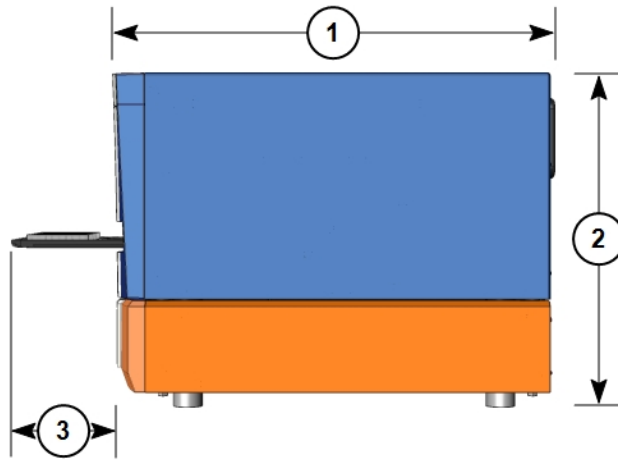

Figure B-6: Side View: SpectraMax i3x with Dimensions

Item	Description
1	Depth: 60.55 cm (23.84 in.)
2	Height: 44.59 cm (17.56 in.)
3	Maximum Length of Opened Plate Drawer: 17.5 cm (6.8 in.)

Electromagnetic Compatibility

Regulatory Information for Canada (ICES/NMB-001:2020)

This ISM device complies with Canadian ICES-001.

Cet appareil ISM est conforme à la norme NMB-001 du Canada.

ISM Equipment Classification (Group 1, Class A)

This equipment is designated as scientific equipment for laboratory use that intentionally generate and/or use conductively coupled radio-frequency energy for internal functioning, and are suitable for use in all establishments, other than domestic and those directly connected to a low voltage power supply network which supply buildings used for domestic purposes.

Contact Us

Phone: [+1-800-635-5577](tel:+1-800-635-5577)
Web: moleculardevices.com
Email: info@moldev.com

Visit our website for a current listing of worldwide distributors.